



Componenti Elettrici e Prefabbricati



Catalogo cabine elettriche prefabbricate in C.A.V.

*Prefabricated electrical substations
made with vibrated reinforced concrete*



Componenti Elettrici e Prefabbricati

WE TAKE CARE
OF ENERGY



La C.E.P. s.r.l. è una realtà costruttiva e commerciale italiana che si contraddistingue per una produzione improntata alla massima qualità, efficienza e flessibilità al fine di soddisfare le esigenze di ogni utente.

La struttura organizzativa, l'elevata qualità delle lavorazioni, l'affidabilità di un servizio sicuro e puntuale, il costante aggiornamento dei macchinari e delle professionalità interne hanno fatto della C.E.P. una realtà imprenditoriale in costante crescita.

CEP is an Italian production and trade reality characterised by production based on the highest levels of quality, efficiency and flexibility in order to meet each users needs.

Its organization, the high quality of its workmanship, the reliability of a safe and punctual service, the constant updating of its machinery and internal professional skills have allowed CEP to become a growing business reality.



L'esperienza acquisita e la solidità ormai affermata ha permesso alla CEP l'acquisizione di clienti importanti nel mercato nazionale e internazionale, consentendole la realizzazione di una vasta gamma di manufatti volti a risolvere qualsiasi problema di impiantistica.

CEP's longstanding experience and solidity have allowed CEP to secure important Italian and international customers and to produce a wide range of products in order to solve any problem in the plants

CEP è garanzia sia di qualità che di serietà commerciale ed è specializzata nella produzione di cabine elettriche prefabbricate in cemento armato vibrato complete di apparecchiature elettromeccaniche, progettazione e produzione di quadri elettrici MT/BT, produzione di interruttori di manovra sezionatori di media tensione e nella realizzazione di articoli tecnici su disegni e richieste specifiche dei Clienti ed Enti Nazionali ed Esteri per la distribuzione di energia elettrica.

Alla crescita in termini quantitativi del prodotto da sempre corrisponde un'uguale attenzione al profilo della qualità. Infatti, la CEP attua e mantiene un efficiente Sistema di gestione Qualità secondo lo standard delle Norme UNI EN ISO 9001.

Inoltre da sempre la CEP ha dedicato grande attenzione ai temi della sicurezza, della salute e al rispetto dell'impatto ambientale del proprio prodotto, e perciò si è prodigata per la realizzazione di cabine che, pur mantenendo elevate prestazioni, garantiscono la sicurezza degli operatori e degli utenti e non deturpano l'ambiente.

La rete di vendita, operativa e capillare sull'intero territorio nazionale, segue il cliente sin dall'inizio del contatto, instaurando un rapporto di fiducia e collaborazione e prestando consigli sulle scelte più consone alle sue esigenze.

CEP guarantees quality and business reliability and it's specialized in producing prefabricated electric stations built of vibrated reinforced concrete and supplied with electromechanical equipment, MV/LV panel boards, in MV disconnecter switches and in executing of design and manufacturing technical articles based on specific drawings production and requests of customers and Italian as well as foreign Authorities for the distribution of electric energy.

This growth in terms of quantity has always been associated with a great attention to quality. In fact, CEP implements and maintains an efficient Quality and Environmental Management System in accordance with UNI EN ISO 9001.

Moreover, CEP has always been interested in health, safety and environmental respect matters and has done its utmost in creation of stations that assure operators and users' safety and don't disfigure the environment, though maintaining the highest standards.

The sales network, operating and diffused all over the country, provides customer care from the beginning of the cooperation, establishing a relationship based on trust and collaboration and leading customers to the most suitable choices in order to satisfy their needs.

ASSISTENZA TECNICA PRE E POST VENDITA

Ci prendiamo cura del cliente e facciamo nostre le sue esigenze. La professionalità unita alla premurosità e alla cortesia sono alla base del nostro rapporto con chi sceglie di lavorare con noi. Ogni nuova iniziativa per progetti custom è frutto di studi preliminari sulla sua concreta attuabilità. Forniamo tempestivamente le giuste soluzioni per ogni diversa richiesta.

PRE-SALES AND POST-SALES TECHNICAL SERVICES

We take care of customers and we turn their needs into ours. Professionalism, thoughtfulness and kindness underlie the business relation with those who choose to work with us. Every new custom project's initiative is consequence of preliminary technical studies about its real feasibility. We promptly supply the right solutions for each types of demand.

CEP è certificata/CEP is certified

Member of CISO Federation



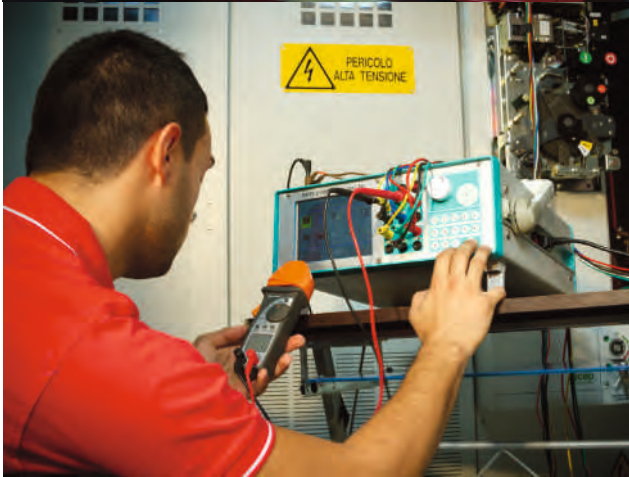

SERVIZI TECNICI

- Supporto telefonico
- Pronto intervento su chiamata
- Supporto tecnico alla manutenzione straordinaria
- Assistenza e ricambi garantiti nel tempo
- Adeguamenti normativi

 NUMERO VERDE
SERVICE TEAM
800-974470

Per installazioni particolari, adeguamenti ed interventi straordinari, al fine di stare accanto ed assistere sia l'utente finale sia l'installatore, CEP ha istituito una task force altamente specializzata operante su tutto il territorio nazionale, denominata **Service Team**.

Componenti Elettrici e Prefabbricati

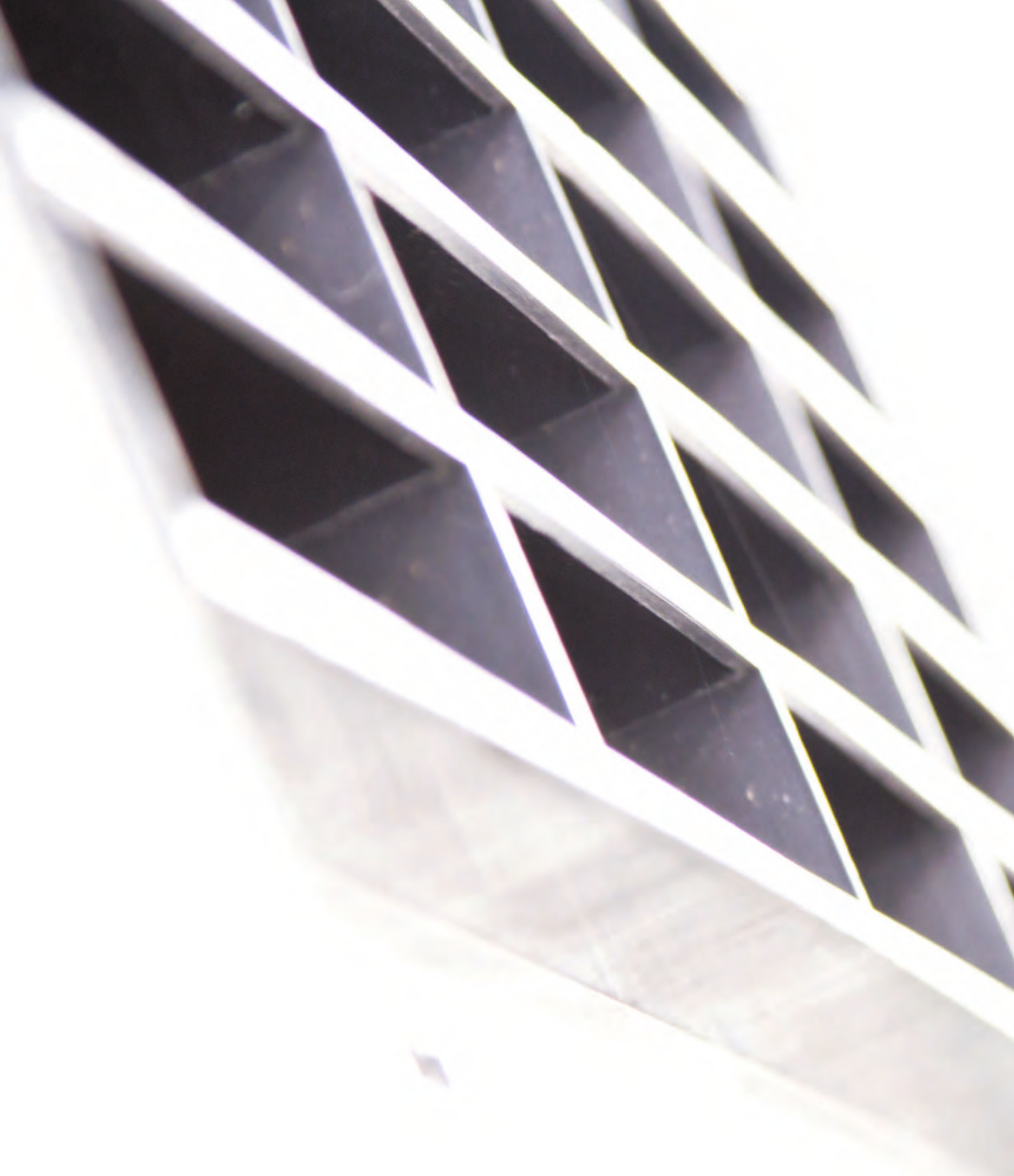

WE TAKE CARE
OF ENERGY

INDICE/INDEX

- pag.8** Caratteristiche generali
- pag.10** Dimensioni e pesi box
- pag.12** Box P25
- pag.13** Box P33
- pag.14** Box P44
- pag.15** Box P57
- pag.16** Box P67
- pag.17** Box P87
- pag.19** Minibox e-distribuzione DG2081 Ed.05
- pag.20** Microbox Plus e-distribuzione DG10200 Ed.01
- pag.22** Box P57 e-distribuzione DG2061/1 Ed.09 "Standard Box Distribuzione"
- pag.23** Scavo e rete di terra come da specifica e-distribuzione DG2061/1 Ed.09
- pag.25** Box P67 e-distribuzione DG2061/7 Ed.09 "Standard Box Cliente"
- pag.26** Box P57 e-distribuzione DG2061/10 Ed.09 "Standard Box Cliente Rid"
- pag.27** Box P67 e-distribuzione DG2061/4 Ed.09 "Standard Box Satellite"
- pag.28** Box P67 e-distribuzione DG2061/7 Ed.09 "Standard Box Cliente" - Partenza Linea
- pag.29** Box P67 e-distribuzione DG2061/7 Ed.09 "Standard Box Cliente" - P25-002 fino a 400 kVA olio
- pag.30** Box P67 e-distribuzione DG2061/7 Ed.09 "Standard Box Cliente" - P25-002 fino a 400 kVA resina
- pag.31** Box P67 e-distribuzione DG2061/7 Ed.09 "Standard Box Cliente" - P33-001 fino a 1000 kVA olio
- pag.32** Box P67 e-distribuzione DG2061/7 Ed.09 "Standard Box Cliente" - P33-002 fino a 1600 kVA resina
- pag.33** Box P67 e-distribuzione DG2061/7 Ed.09 "Standard Box Cliente" - P44-001 fino a 1600 kVA olio
- pag.34** Box P67 e-distribuzione DG2061/7 Ed.09 "Standard Box Cliente" - P44-002 fino a 1600 kVA resina
- pag.35** Box P67 e-distribuzione DG2061/7 Ed.09 "Standard Box Cliente" - P57-001 fino a 2x400 kVA olio
- pag.36** Box P67 e-distribuzione DG2061/7 Ed.09 "Standard Box Cliente" - P57-002 fino a 2x400 kVA resina
- pag.37** Box P67 e-distribuzione DG2061/7 Ed.09 "Standard Box Cliente" - P67-001 fino a 2x1000 kVA olio
- pag.38** Box P67 e-distribuzione DG2061/7 Ed.09 "Standard Box Cliente" - P67-002 fino a 2x1000 kVA resina
- pag.39** Box P67 e-distribuzione DG2061/7 Ed.09 "Standard Box Cliente" - P67-003 fino a 2x1250 kVA olio
- pag.40** Box P67 e-distribuzione DG2061/7 Ed.09 "Standard Box Cliente" - P67-004 fino a 2x1250 kVA resina
- pag.41** P33 SI fino a 400 kVA
- pag.43** Sezioni tipo
- pag.45** Condizioni per lo scarico



Cabine elettriche prefabbricate in C.A.V.

Prefabricated vibrated concrete Stations

CARATTERISTICHE GENERALI

I box prefabbricati CEP, destinati a cabine elettriche di trasformazione per Enti distributori e per utenti privati, sono identificati come monoblocchi tridimensionali prefabbricati a unico getto in conglomerato cementizio armato vibrato.

GENERAL FEATURES

CEP's prefabricated boxes, designed for electrical transformer stations for Distributor Authorities and private customers, are identified as single jet three-dimensional prefabricated monoblocs made with vibrated concrete.

Dimensioni

I box sono prodotti in serie dichiarata e hanno dimensioni standard tali da permettere il trasporto senza scorta né permessi speciali. L'altezza esterna standard è di m 2.55 e può variare, a seconda delle esigenze, fino a raggiungere l'altezza di m 3.00. La larghezza è di m 2.50 mentre la lunghezza varia da m 2.38 a m 6.76. La realizzazione di grandi cabine di trasformazione avviene affiancando più box singoli, oppure è possibile mediante un idoneo giunto tecnico aprire le due pareti adiacenti e collegare internamente le cabine creando un unico locale.

Sizes

Boxes are mass-produced declared and have standard dimensions in order to ship them unescorted and without any special authorization. Standard external height is 2.55 metres and it can change, depending on demands, up to 3.00 metres. The width is 2.50 metres whereas the length can change from 2.38 to 6.76 metres. The production of big transformer stations is carried out putting side by side more than one box or by suitable technical joint which opens the two adjacent walls and connect the stations from the inside creating one room.

Caratteristiche strutturali

La struttura dei box è realizzata utilizzando un calcestruzzo RcK 40 Kg/cm² – C 32/40, confezionato in stabilimento mediante centrale di betonaggio automatica e additivato con idonei fluidificanti e impermeabilizzanti: ciò permette di ottenere adeguata protezione contro le infiltrazioni d'acqua per capillarità e protezione dall'esterno. L'armatura è realizzata con rete elettrosaldata a doppia maglia, irrigidita agli angoli da barre a doppio T, onde conferire al manufatto una struttura monolitica e una gabbia equipotenziale di terra omogenea su tutta la struttura (gabbia di Faraday).

Structural features

The box's structure is made of RcK 40 kg/cm³ – C 32/40 concrete, packaged in factory by automatic concrete plant and added with appropriate fluidifying and waterproofing substances: then it's possible to obtain the right protection against water infiltrations caused by capillarity and at the same time the protection from the outside. The frame is made with double link mesh, stiffened at the corners by double T bars, in order to create a monolithic structure and an equipotential cage made of homogeneous soil over the entire structure (Faraday's cage).

Finiture

I box sono rifiniti con la massima cura e a perfetta regola d'arte, sia internamente che esternamente, e tinteggiati con pitture murali plastiche idrorepellenti costituite da resine sintetiche pregiate, polvere di quarzo, ossidi, coloranti e additivi, al fine di assicurare il perfetto ancoraggio sul manufatto e la resistenza agli agenti atmosferici, anche in ambienti industriali e marini. Per il montaggio degli infissi vengono disposti appositi controtelai che garantiscono la collocazione di infissi in vetroresina, alluminio etc.

Finishing touches

Boxes are workmanlike finished off both inside and outside and painted by water-repellent plastic mural painting made of fine synthetic resin, quartz powder, oxides, dyes and additives, in order to ensure the perfect anchorage on the handwork and the resistance against the weathering, in industrial and marine environments too. Appropriate counterframes are placed for the installation of fixtures in order to guarantee the collocation of fibreglass, aluminium frames, etc.

TABELLA COLORI COLOR CHART

Facciate esterne <i>External walls</i>	RAL 1011	
Tetto <i>Roof</i>	RAL 7001	
Pareti e soffitti interni <i>Inside walls and ceilings</i>	RAL 9010	
Pavimento interno <i>Inside floor</i>	RAL 7001	

Colori diversi realizzabili su richiesta
Different colors available on demand

Tutti i componenti da noi prodotti, oltre a vantare tutte le certificazioni e le conformità alle norme CEI e IEC, sono da anni omologati ENEL, con cui vantiamo un'esperienza pluriennale nella conoscenza del mercato nazionale definendoci partner industriali.

All the components we produce boast all the certifications and the compliances to CEI and IEC standards and are homologated by ENEL, our industrial partner, with which we can boast years of experience in the knowledge of home market.





Impianto elettrico e di terra

I box vengono corredati d'impianto elettrico sfilabile con tubazioni sottotraccia, atto a determinare idonea illuminazione dei locali, prese di servizio e collettore di terra costituito da una piattina in rame collegata all'intera struttura che garantisce l'equipotenzialità.

Electrical and ground plant

The boxes are equipped with removable electrical plant with buried pipes in order to bring appropriate illumination in the rooms; and it's also equipped with service sockets and ground collector made of copper saucer connected to the whole structure that guarantees the equipotential.

Dimensioni, pesi e misure per lo scavo

Sizes and weights of the boxes

Tipologia cabina Type of station	Scavo Excavation Metri/Metres:			Cabina Box Metri/Metres:			Boxvuoto Emptybox kg	Peso della vasca Weight of the basement kg
	lunghezza length	larghezza width	profondità depth	lunghezza length	larghezza width	altezza height		
P25	4,50	3,50	0,62	2,38	2,50	2,55/3,00	8000	2700
P33	5,50	3,50	0,62	3,28	2,50	2,55/3,00	12000	3200
P44	6,50	3,50	0,62	4,48	2,50	2,55/3,00	13000	4500
P57	8,00	3,50	0,62	5,77	2,50	2,55/3,00	16000	6000
P67	9,00	3,50	0,62	6,76	2,50	2,55/3,00	19000	6500
P87	10,70	3,50	0,62	8,70	2,50	3,12*	28000*	-

* Compreso vasca integrata.

Norme di riferimento
Standards
D.M. 14/01/2008
Nuove norme tecniche antisismiche
New technical antiseismic norms
CEI EN 62271-202 and CEI 17-103
Sottostazioni prefabbricate
ad alta tensione/bassa tensione
*High voltage/low voltage prefabricated
substation*
Specifica Enel
Enel specification

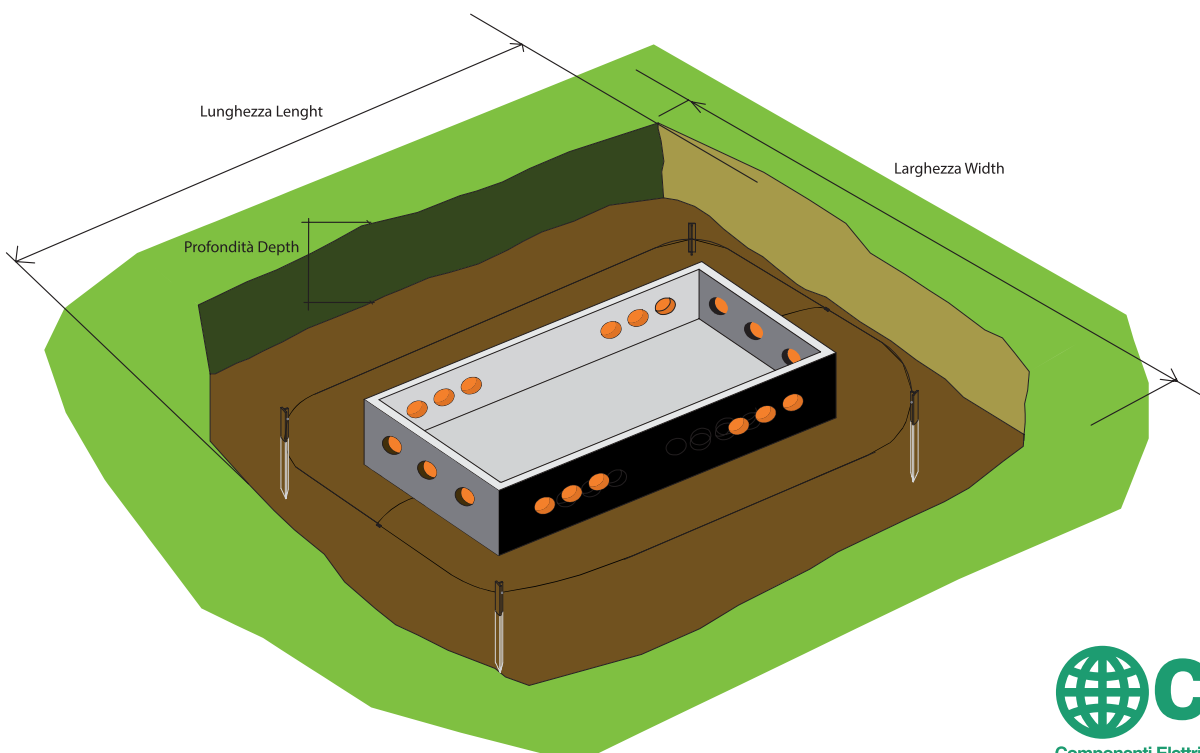
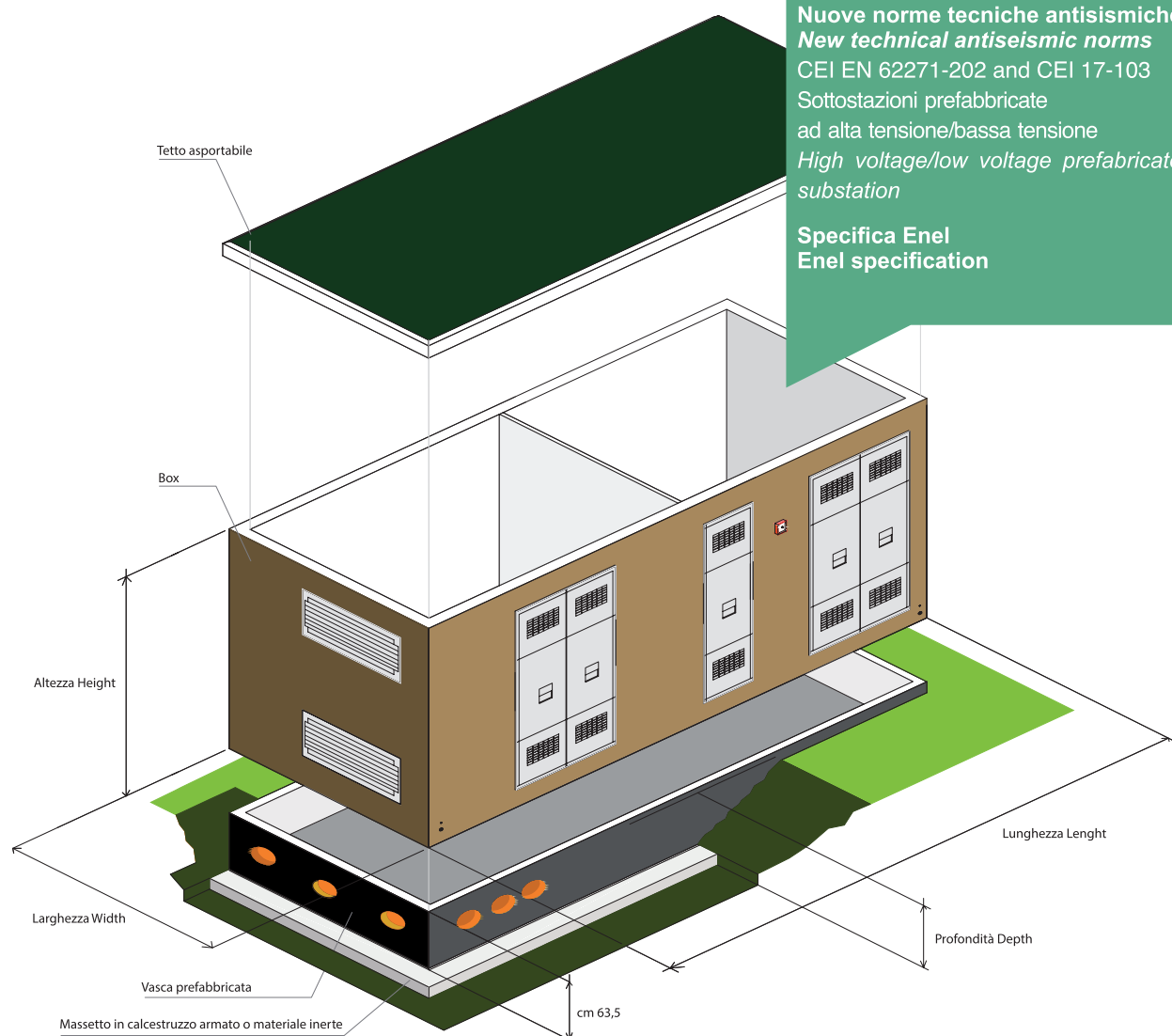

Box P25

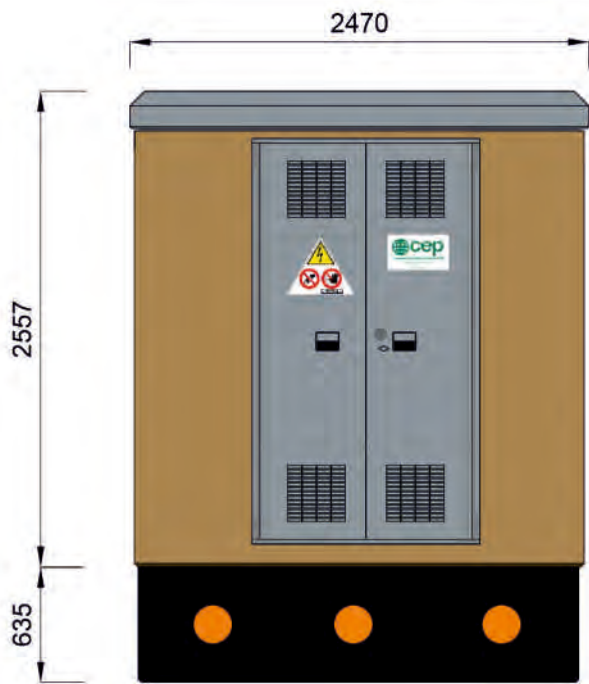

Vista Frontale
Frontal view

Quote e dimensioni scavo
Digging quota and dimensions

Lunghezza - Length	m	3,00
Larghezza - Width	m	3,50
Profondità - Depth	m	0,60

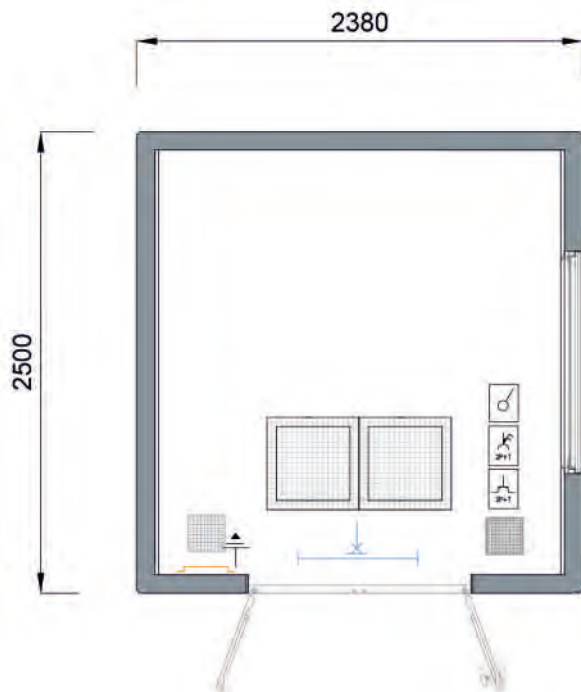

Vista su pianta
Plant view

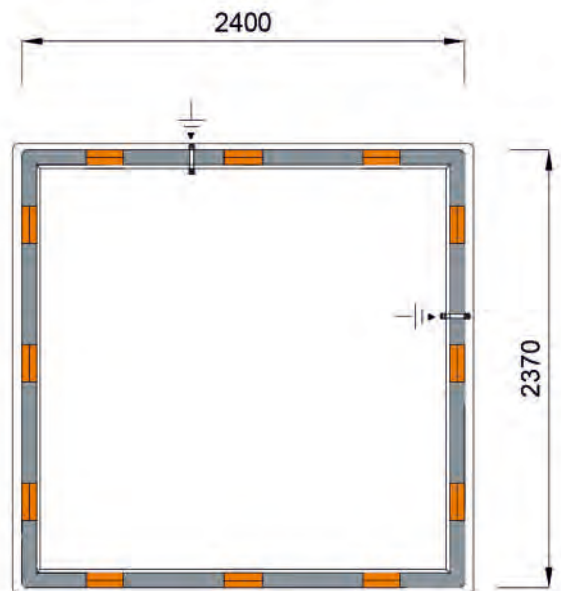

Vista su pianta vasca
Foundation plant view

Box P33

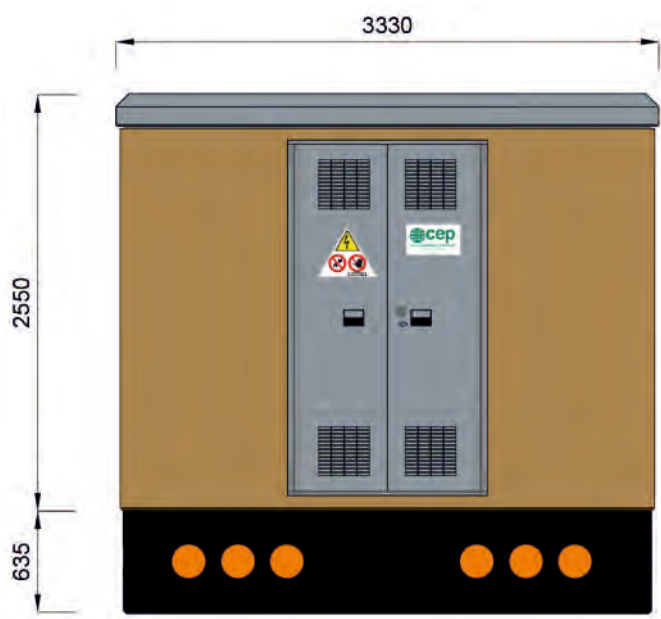

Vista Frontale
Frontal view

Quote e dimensioni scavo Digging quota and dimensions

Lunghezza - Length	m	5,50
Larghezza - Width	m	3,50
Profondità - Depth	m	0,60

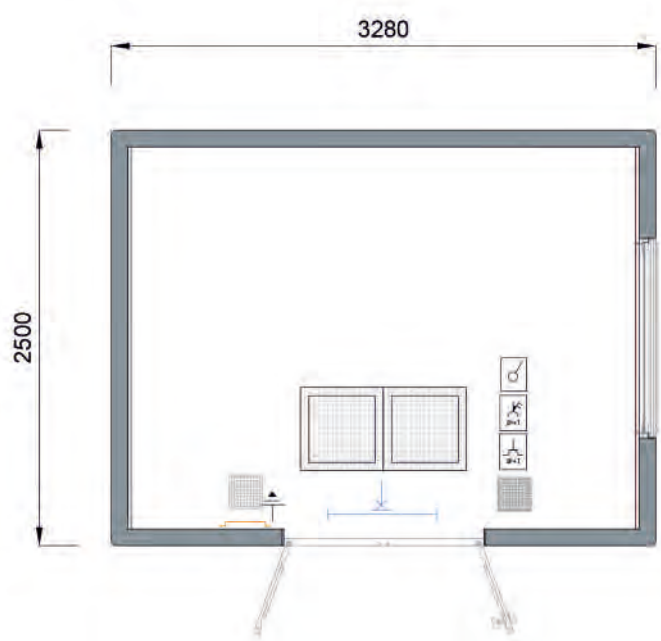
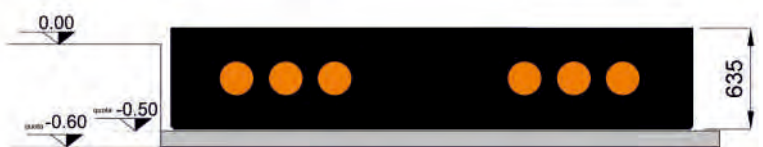

Vista su pianta
Plant view

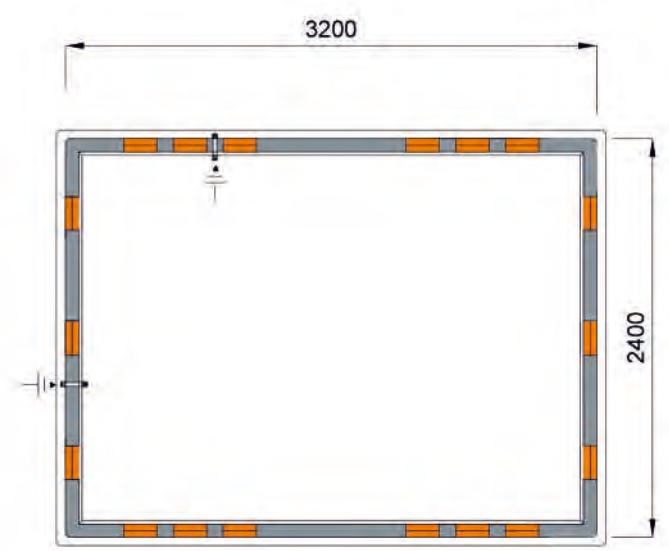

Vista su pianta vasca
Foundation plant view

Box P44

Quote e dimensioni scavo
Digging quota and dimensions

Lunghezza - Length	m	6,50
Larghezza - Width	m	3,50
Profondità - Depth	m	0,60

 Vista Frontale
 Frontal view

 Vista su pianta
 Plant view

 Vista Frontale
 Frontal view

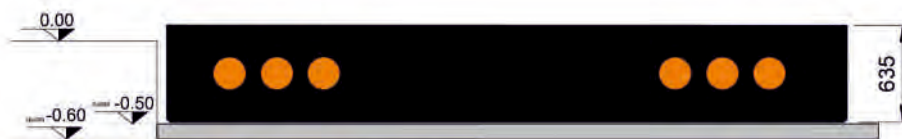
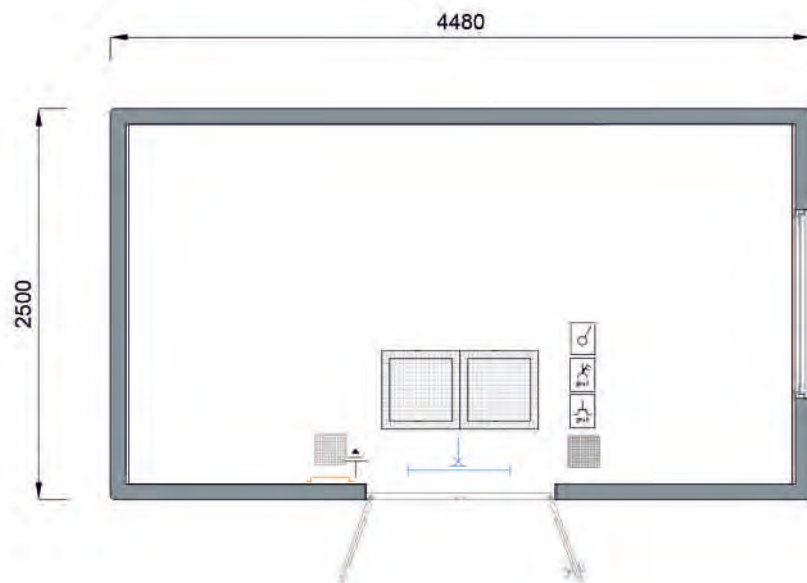
 Vista su pianta vasca
 Foundation plant view

VISTA FRONTALE FRONT VIEW

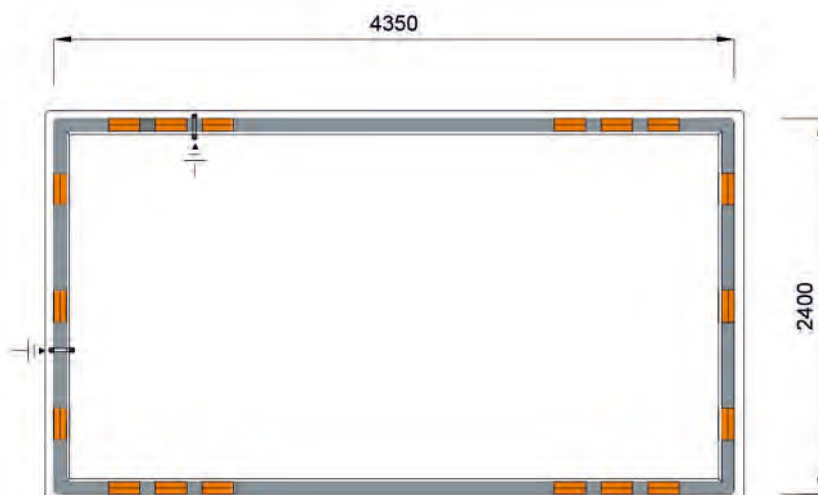

Box P57

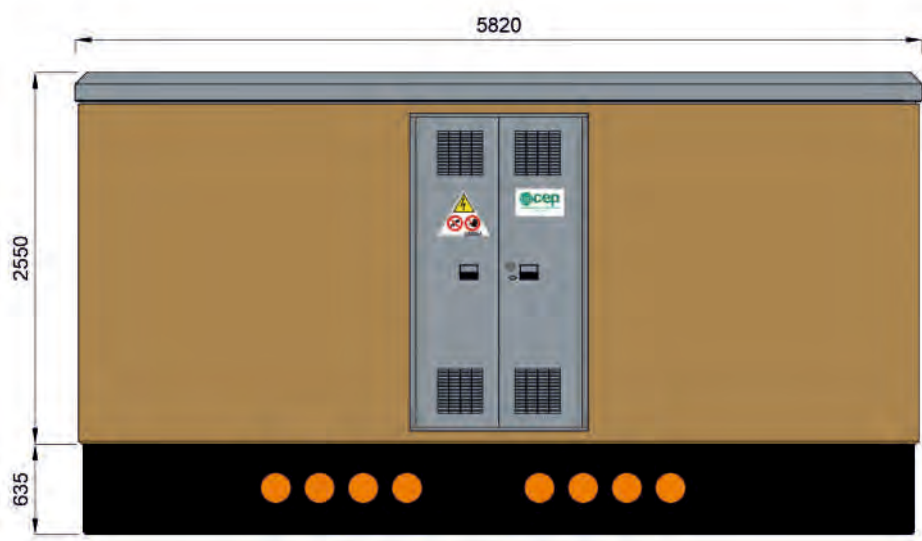

Quote e dimensioni scavo Digging quota and dimensions

Lunghezza - Length	m	8,00
Larghezza - Width	m	3,50
Profondità - Depth	m	0,60

Vista Frontale
Frontal view

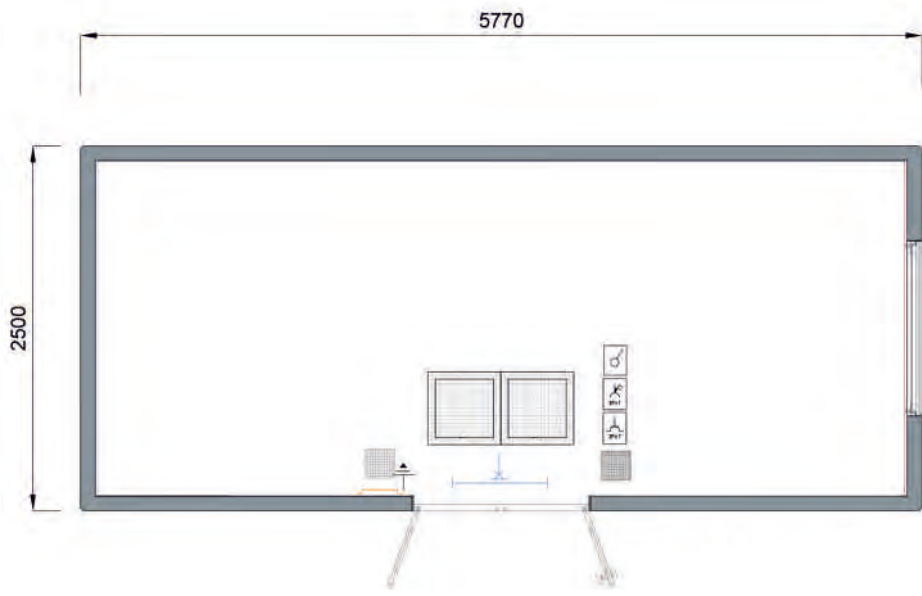

Vista su pianta
Plant view



Vista Frontale
Frontal view

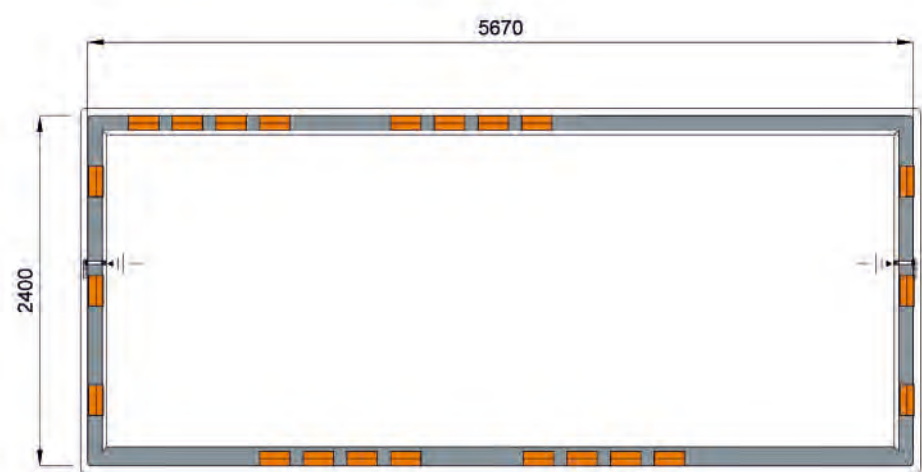

Vista su pianta vasca
Foundation plant view

Box P67

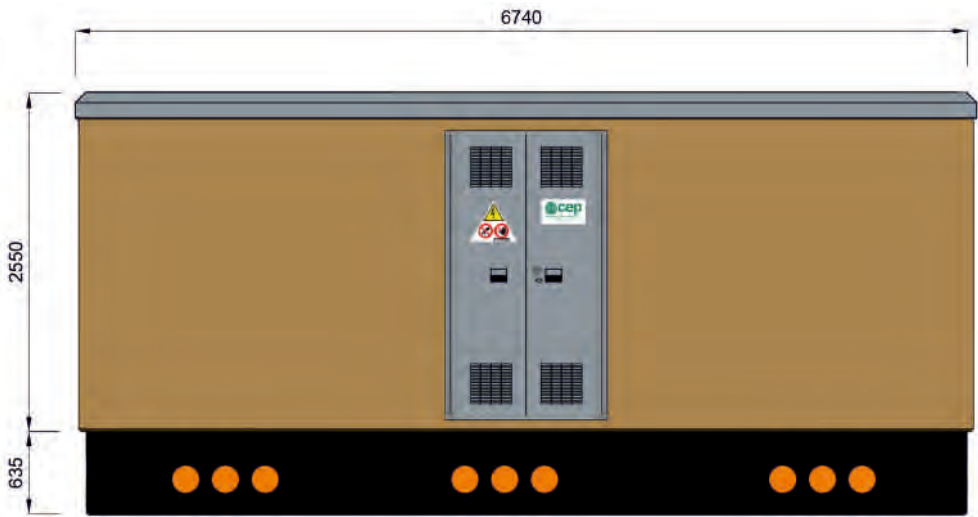

Vista Frontale
Frontal view

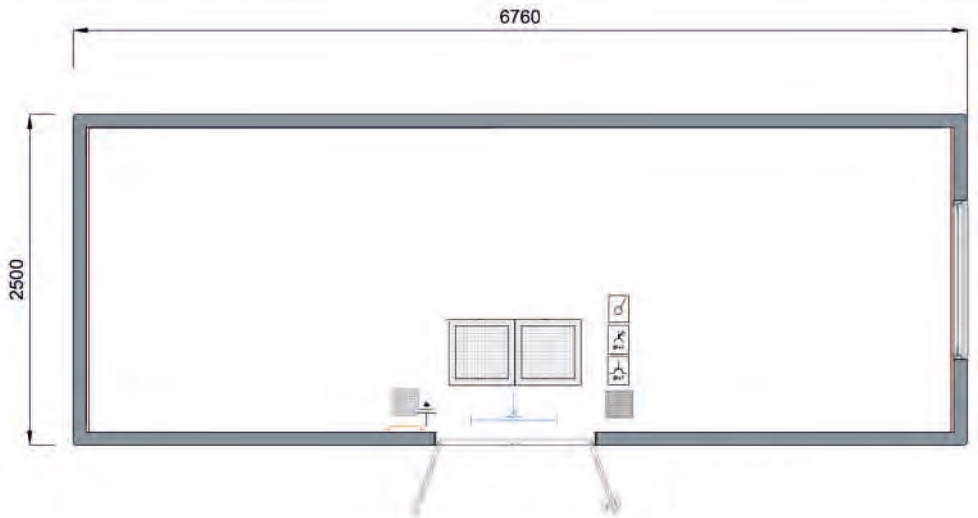

Vista su pianta
Plant view



Vista Frontale
Frontal view

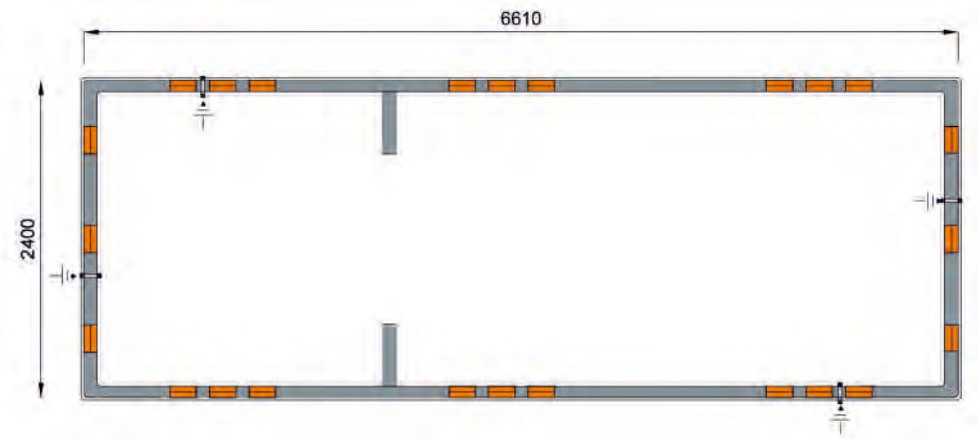

Vista su pianta vasca
Foundation plant view

Quote e dimensioni scavo Digging quota and dimensions		
Lunghezza - Length	m	9,00
Larghezza - Width	m	3,50
Profondità - Depth	m	0,60

Box P87

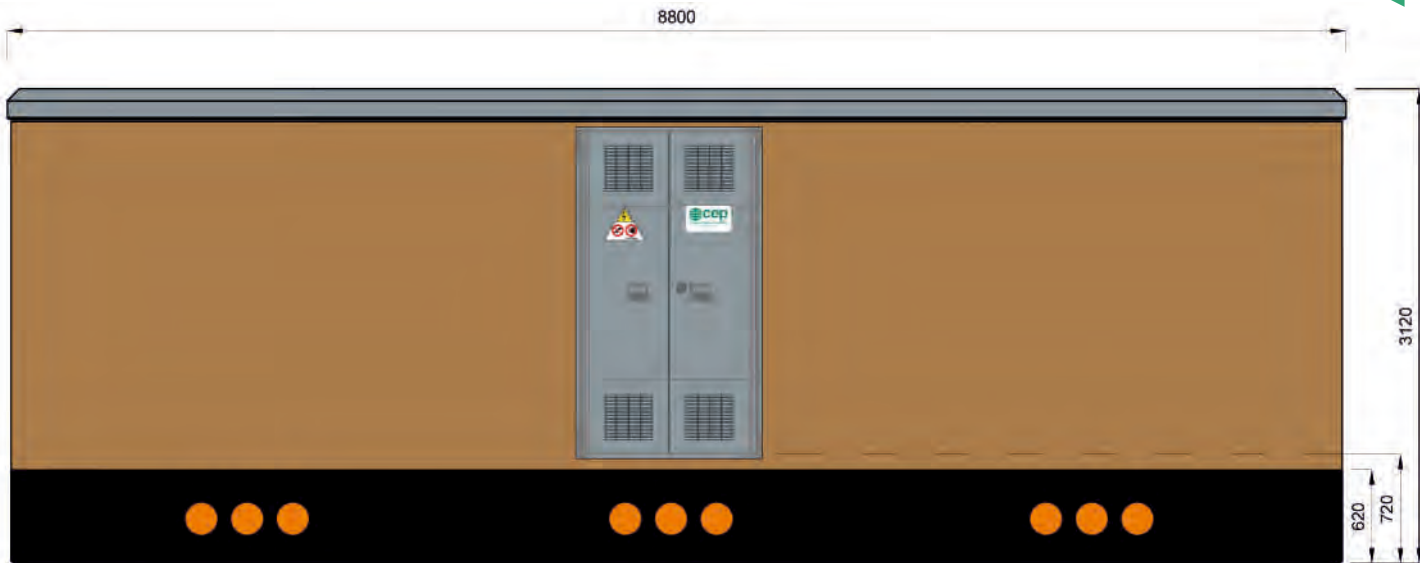

Vista Frontale
Frontal view

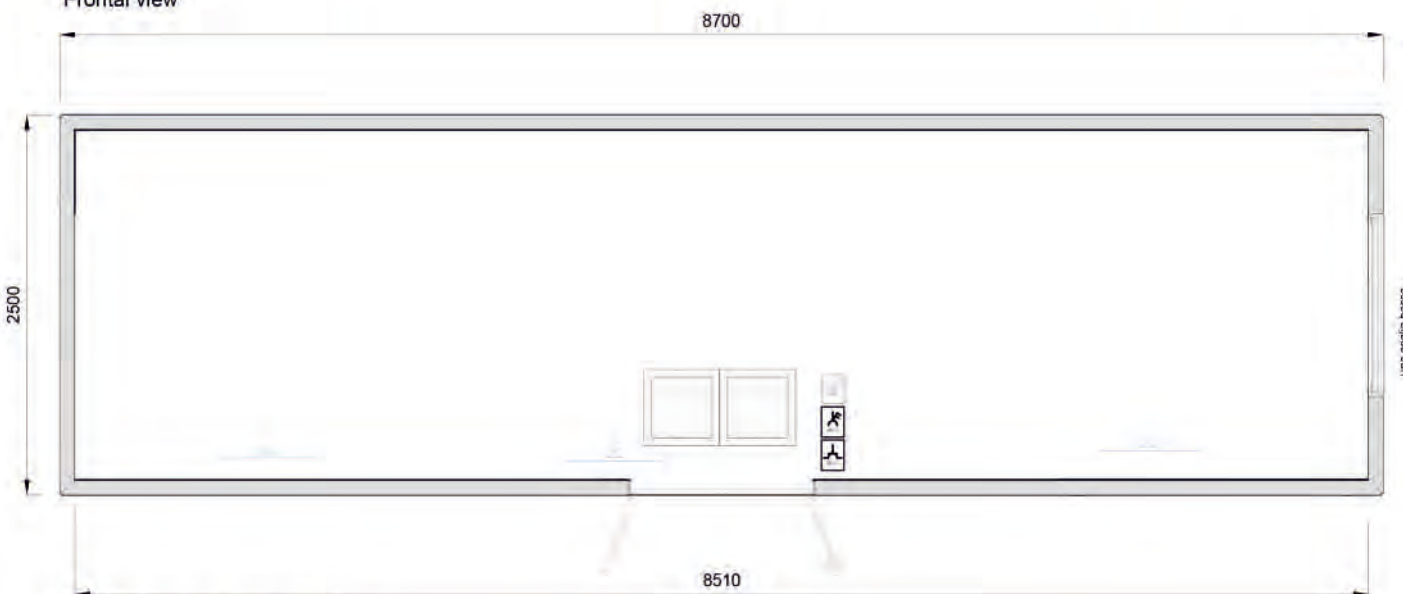

Vista su Pianta della Cabina
Station Plant view

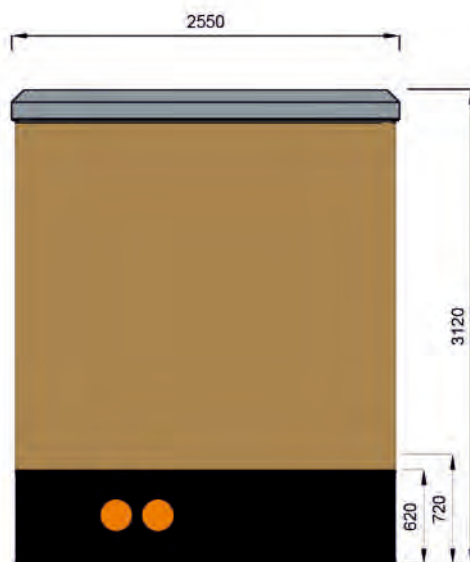

Vista Laterale
Side view

Quote e dimensioni scavo Digging quota and dimensions			
Lunghezza - Length	m	8,70	
Larghezza - Width	m	2,50	
Profondità - Depth	m	0,60	

I disegni potrebbero non essere in scala. The drawings may not be to scale.



Minibox e-distribuzione DG2081 Ed.05

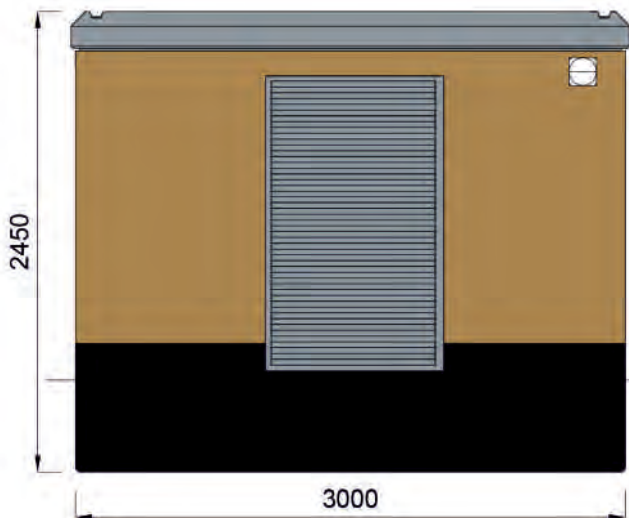

Vista Frontale C
Frontal view C

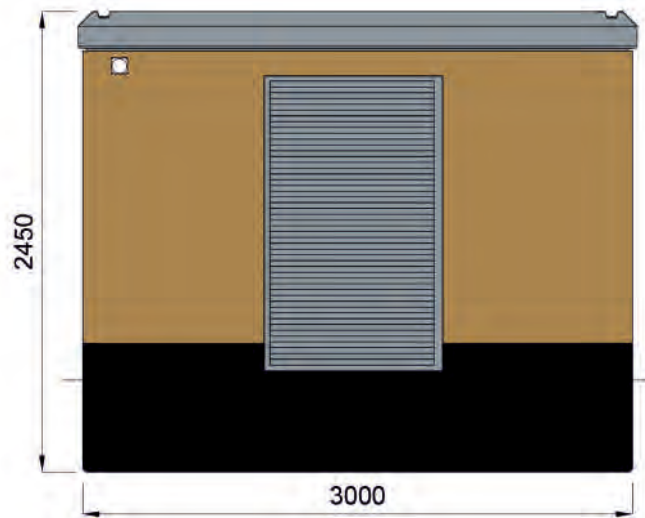

Vista Frontale D
Frontal view D

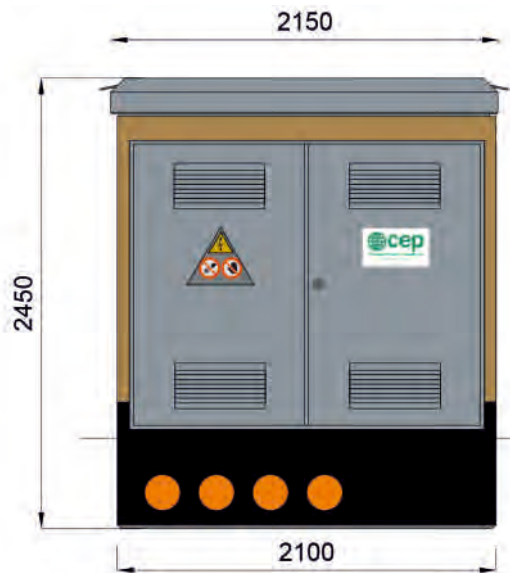

Vista Frontale B
Frontal view B

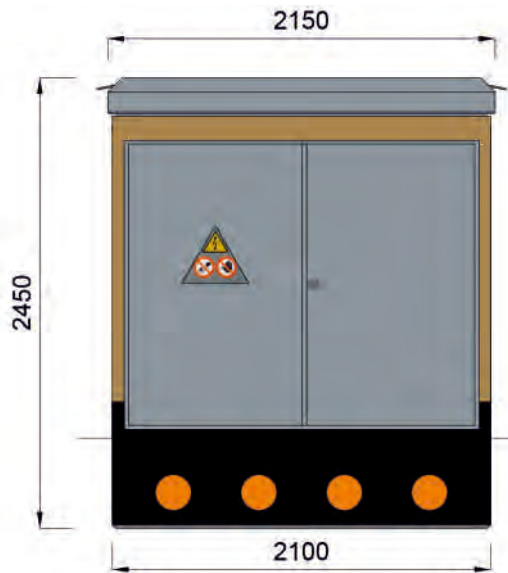

Vista Frontale A
Frontal view A

Quote e dimensioni scavo Digging quota and dimensions

Lunghezza - Length	m	5,00
Larghezza - Width	m	4,00
Profondità - Depth	m	0,50

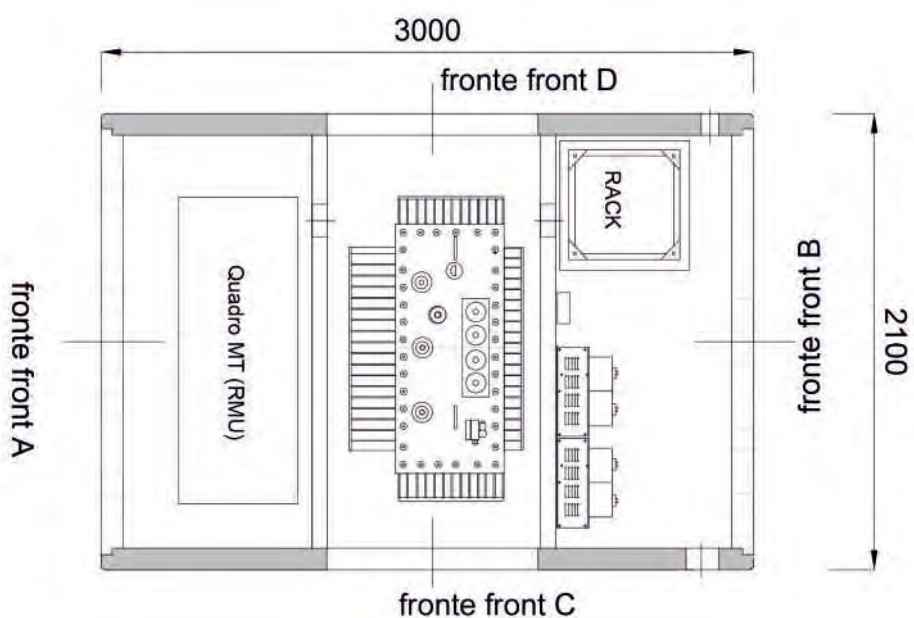

I disegni potrebbero non essere in scala. The drawings may not be to scale.

Microbox Plus e-distribuzione DG10200 Ed.01



fronte - front view B



fronte - front view D

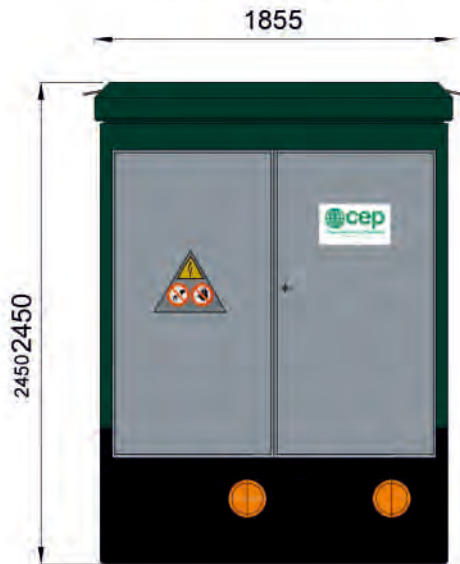

fronte - front view A

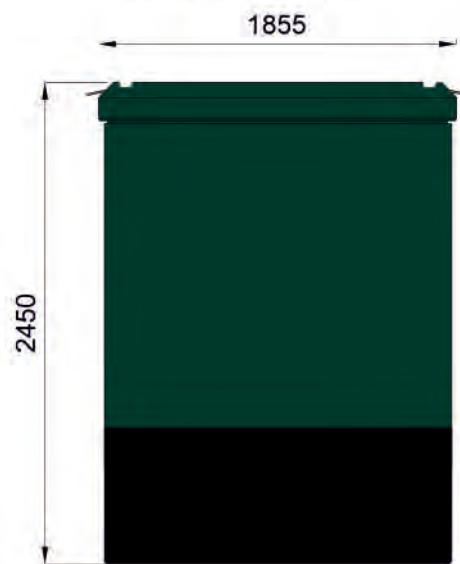

fronte - front view C

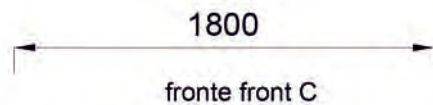

fronte front C

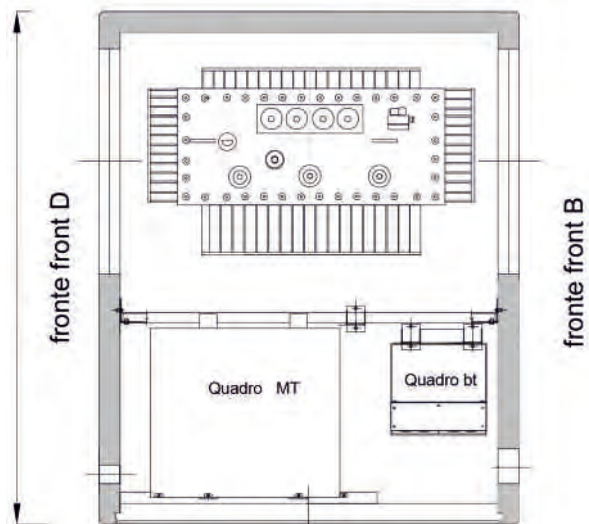

fronte front A

Quote e dimensioni scavo Digging quota and dimensions			
Lunghezza - Length	m	4,50	
Larghezza - Width	m	4,00	
Profondità - Depth	m	0,50	

Microbox Plus e-distribuzione DG10200 Ed.01

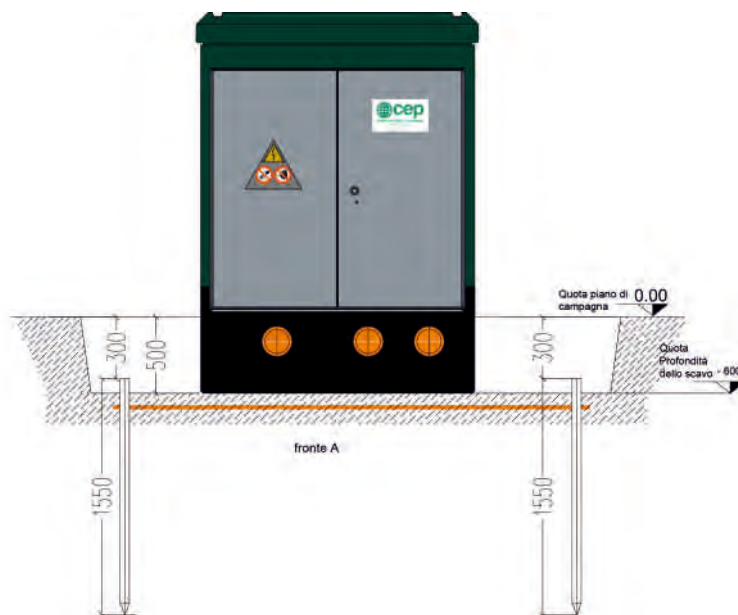

SIGLA	DESCRIZIONE	QUANTITÀ
DR 1015	Paletto di ferro in profilato acciaio (altezza mt 1.55)	5,00
DC 1003	Conduttore a corda di rame/7,56 sezione 35 mmq	0,60
DM 1203	Morsetto bifilare a compressione	0,60
DR 1020	Capocorda a compressione diritto per corda di rame 7,56 con attacco piatto a due fori per paletto	0,60

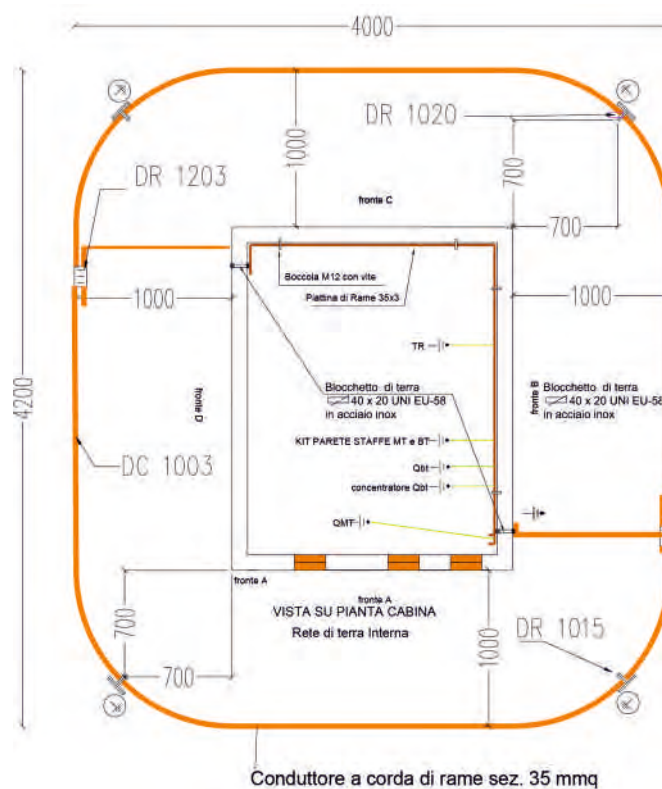

Box P57 e-distribuzione DG2061/1 Ed.09 "Standard Box Distribuzione"

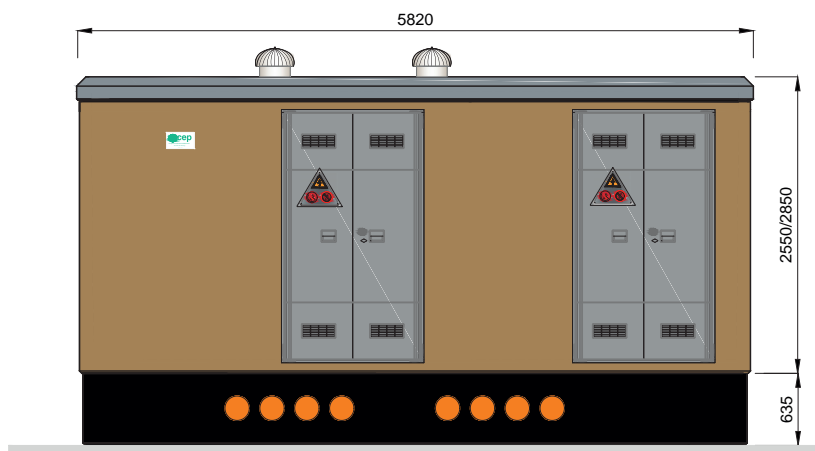

Vista Frontale
Frontal view

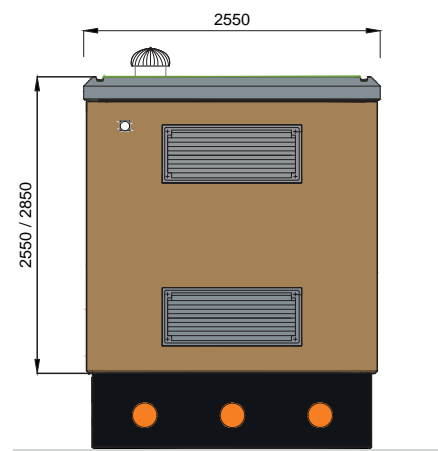

Vista Laterale
Side view

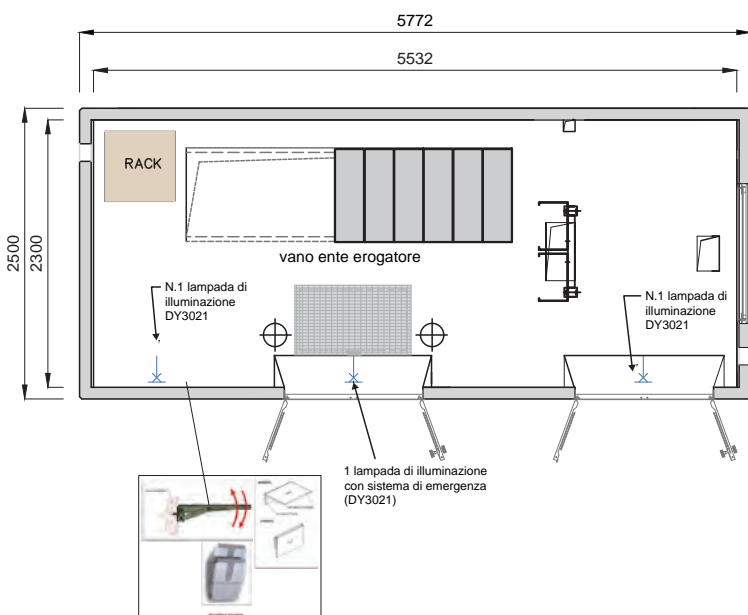

Vista su pianta
Plant view

Pianta cabina P57 Distribuzione

Descrizione	Tipologia	Matricola
Standard Box Distribuzione con porte vetroresina	DG2061 / 1	227280
Standard Box Distribuzione con porte acciaio zincato	DG2061 / 2	227282
Standard Box Distribuzione con porte acciaio inox	DG2061 / 3	227283

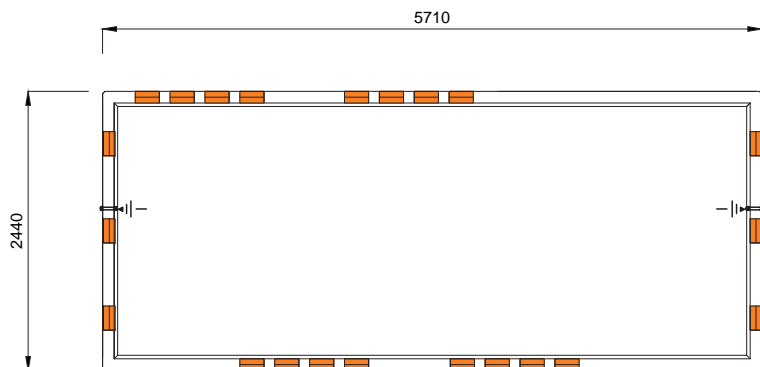

Vista su pianta vasca
Foundation plant view

Quote e dimensioni scavo Digging quota and dimensions

Lunghezza - Length	m	8,00
Larghezza - Width	m	3,50
Profondità - Depth	m	0,60

Scavo e rete di terra come da specifica e-distribuzione DG2061/1 Ed.09

RETE DI TERRA ESTERNA

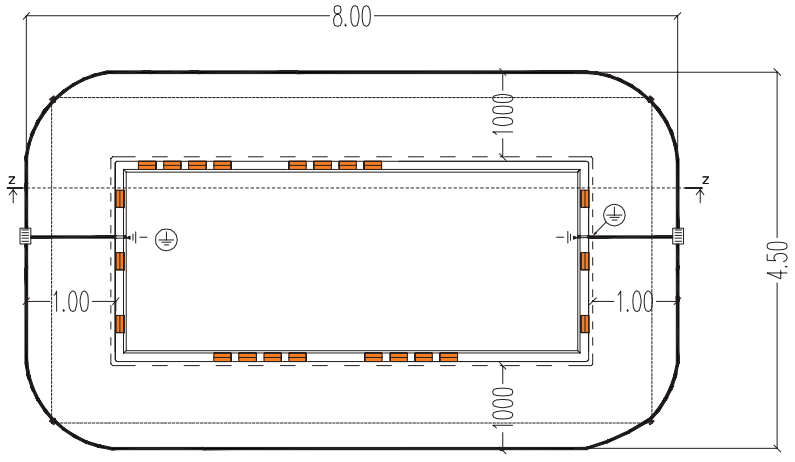

PARTICOLARE SCAVO e RETE DI TERRA

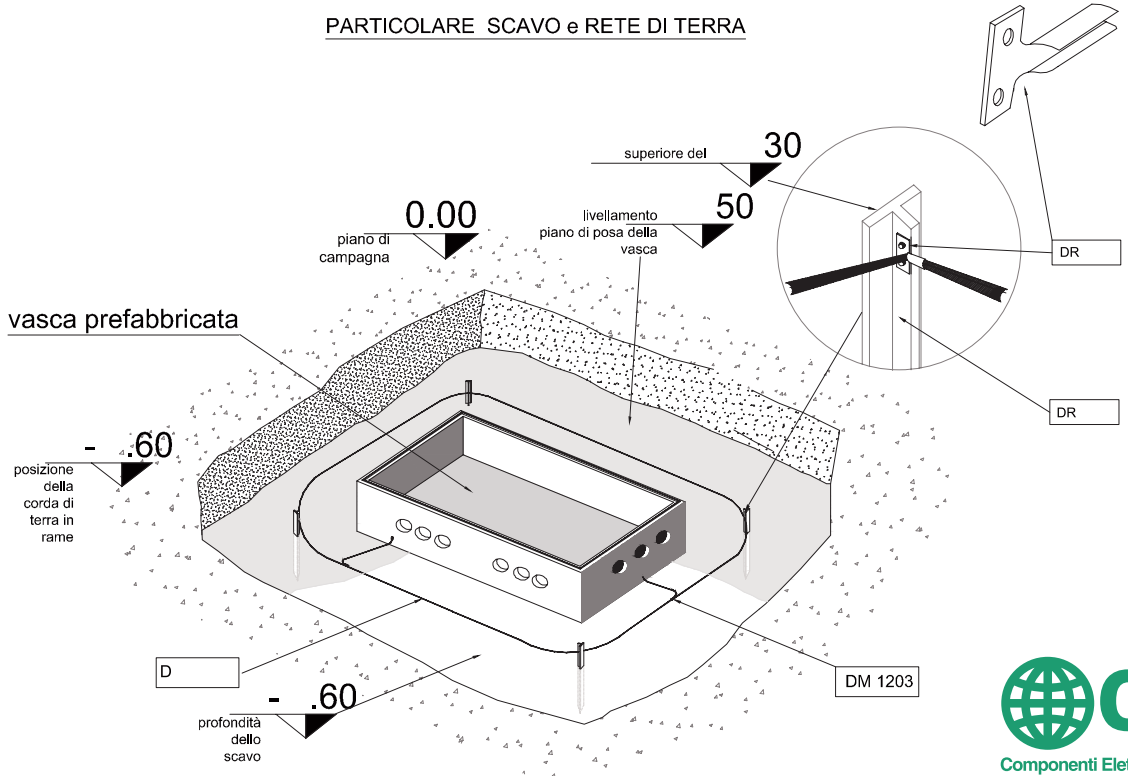



Box P67 e-distribuzione DG2061/7 Ed.09 "Standard Box Cliente"

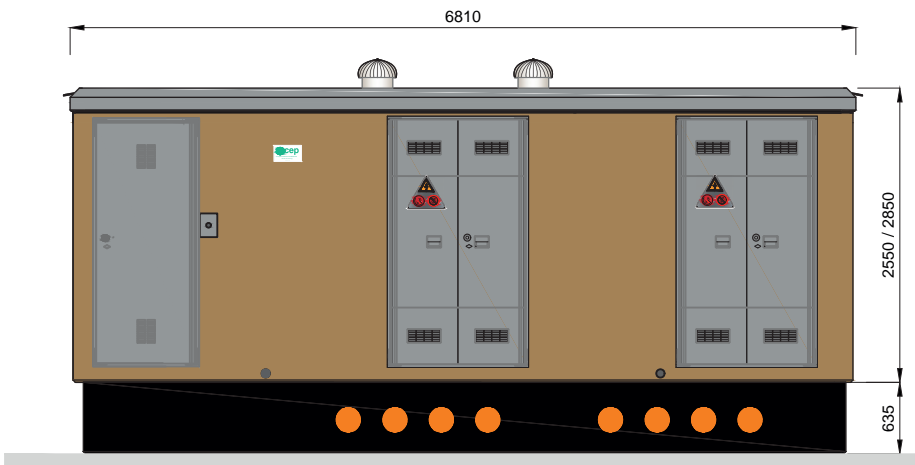

Vista Frontale
Frontal view

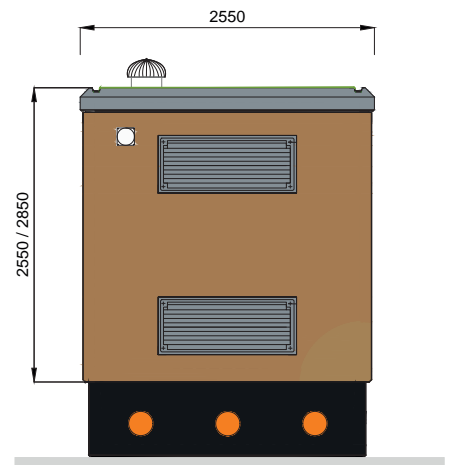

Vista Laterale
Side view

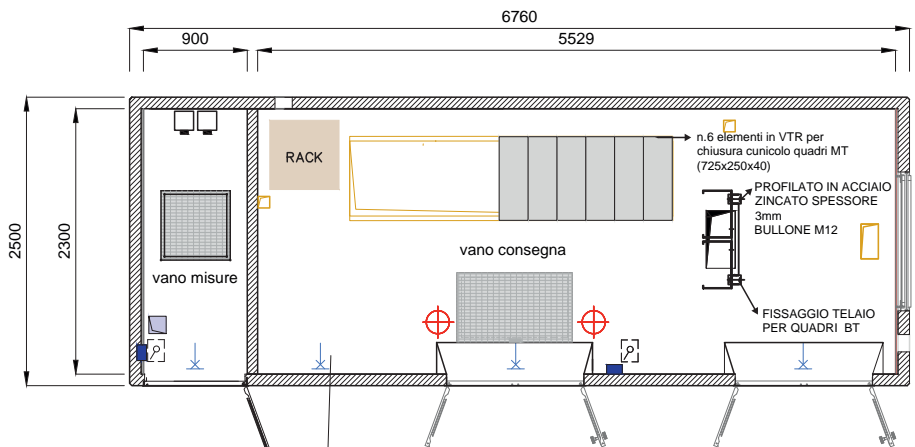

Vista su pianta
Plant view

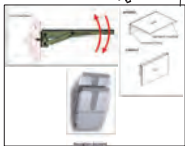

**Pianta cabina P67 DG2061 ED.09
Standard Box Cliente**

Descrizione	Tipologia	Matricola
Standard Box Cliente con porte vetroresina	DG2061 / 7	220008
Standard Box Cliente con porte acciaio zincato	DG2061 / 8	220003
Standard Box Cliente con porte acciaio inox	DG2061 / 9	220002

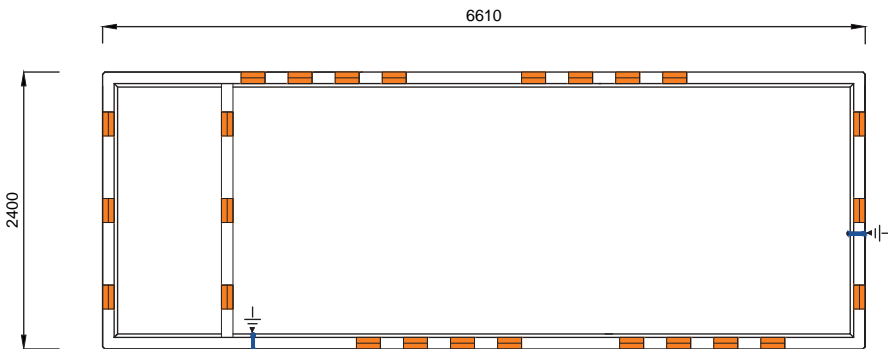

Vista su pianta vasca
Foundation plant view

**Quote e dimensioni scavo
Digging quota and dimensions**

Lunghezza - Length	m	8,00
Larghezza - Width	m	3,50
Profondità - Depth	m	0,60

I disegni potrebbero non essere in scala.

Box P57 e-distribuzione DG2061/10 Ed.09 "Standard Box Cliente Rid"

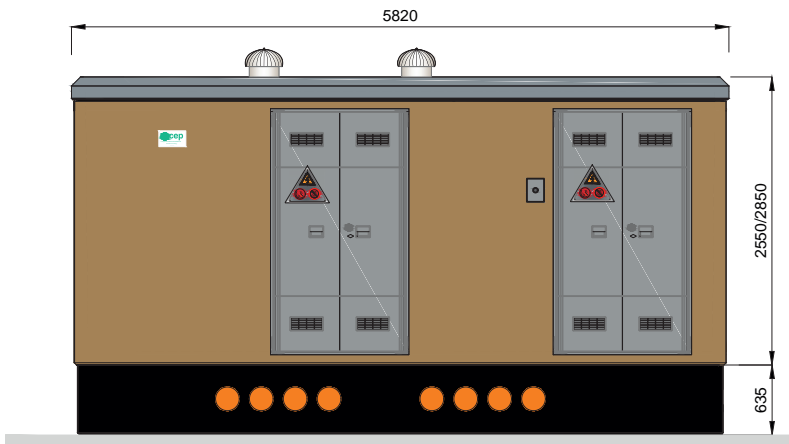

Vista Frontale
Frontal view

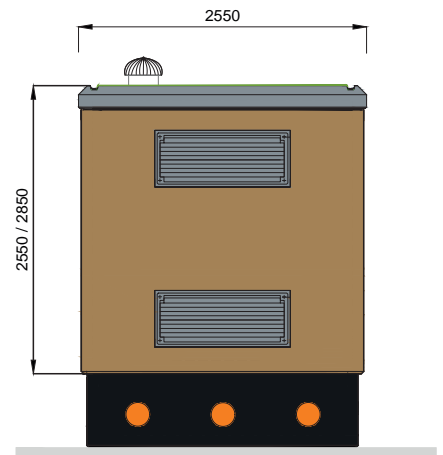

Vista Laterale
Side view

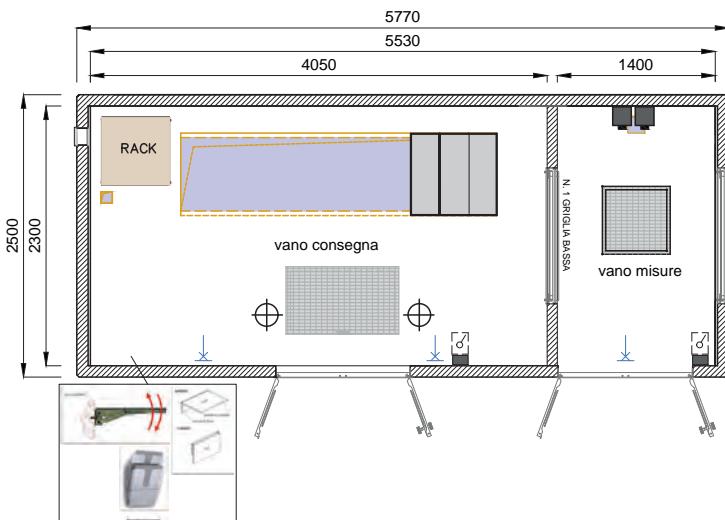

Vista su pianta
Plant view

Pianta cabina P57 DG2061 ED.09 Standard Box Cliente Rid

Descrizione	Tipologia	Matricola
Standard Box Cliente Rid con porte vetroresina	DG2061 / 10	220011
Standard Box Cliente Rid con porte acciaio zincato	DG2061 / 11	220010
Standard Box Cliente Rid con porte acciaio inox	DG2061 / 12	220009

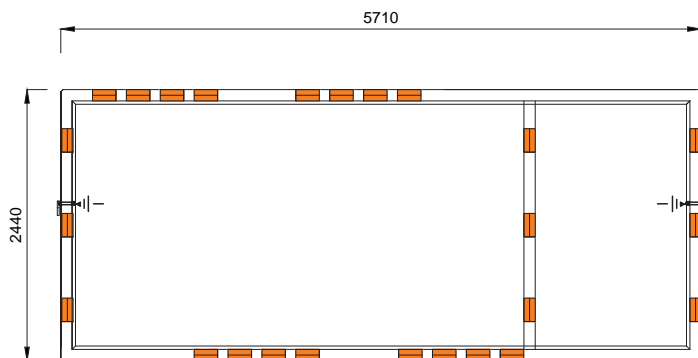

Vista su pianta vasca
Foundation plant view

Quote e dimensioni scavo Digging quota and dimensions

Lunghezza - Length	m	8,00
Larghezza - Width	m	3,50
Profondità - Depth	m	0,60

Box P67 e-distribuzione DG2061/4 Ed.09 "Standard Box Satellite"

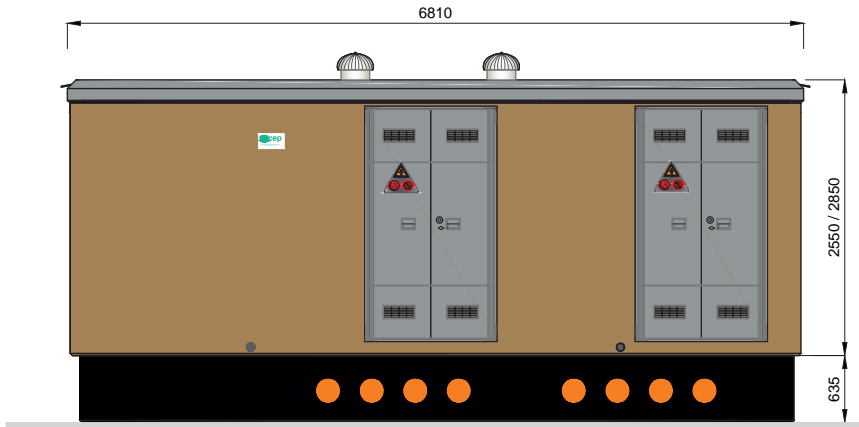

Vista Frontale
Frontal view

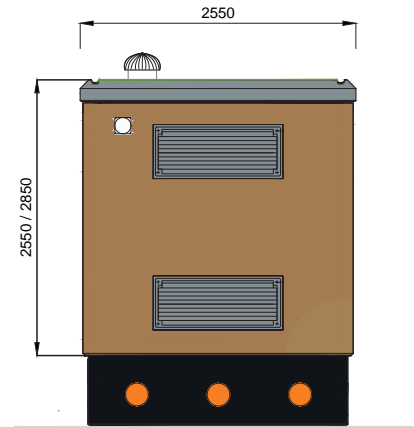

Vista Laterale
Side view

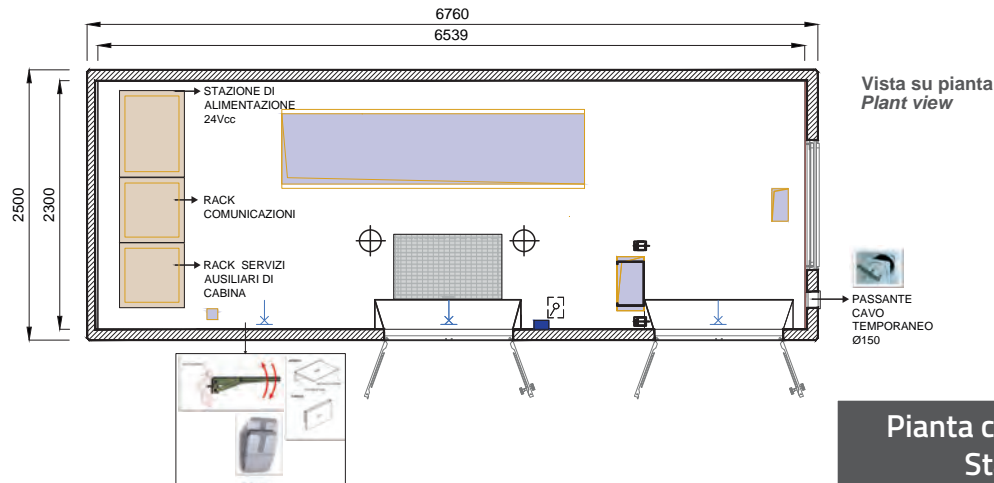

Vista su pianta
Plant view

Pianta cabina P67 DG2061 ED.09 Standard Box Satellite

Descrizione	Tipologia	Matricola
Standard Box Satellite con porte vetroresina	DG2061 / 4	220015
Standard Box Satellite con porte acciaio zincato	DG2061 / 5	220014
Standard Box Satellite con porte acciaio inox	DG2061 / 6	220012

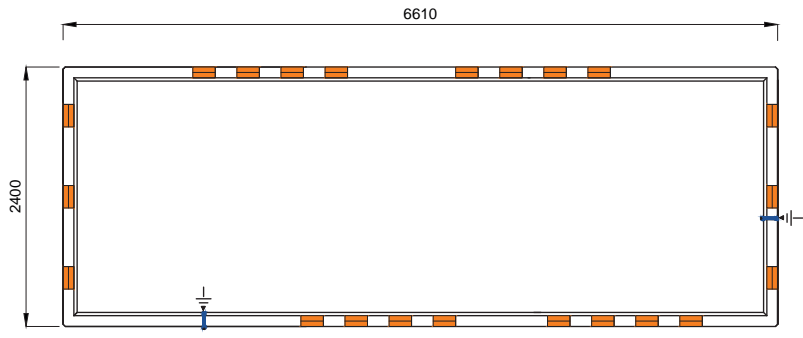

Vista su pianta vasca
Foundation plant view

Quote e dimensioni scavo Digging quota and dimensions

Lunghezza - Length	m	8,00
Larghezza - Width	m	3,50
Profondità - Depth	m	0,60

Box P67 e-distribuzione DG2061/7 Ed.09 "Standard Box Cliente"

P25-001 Partenza linea

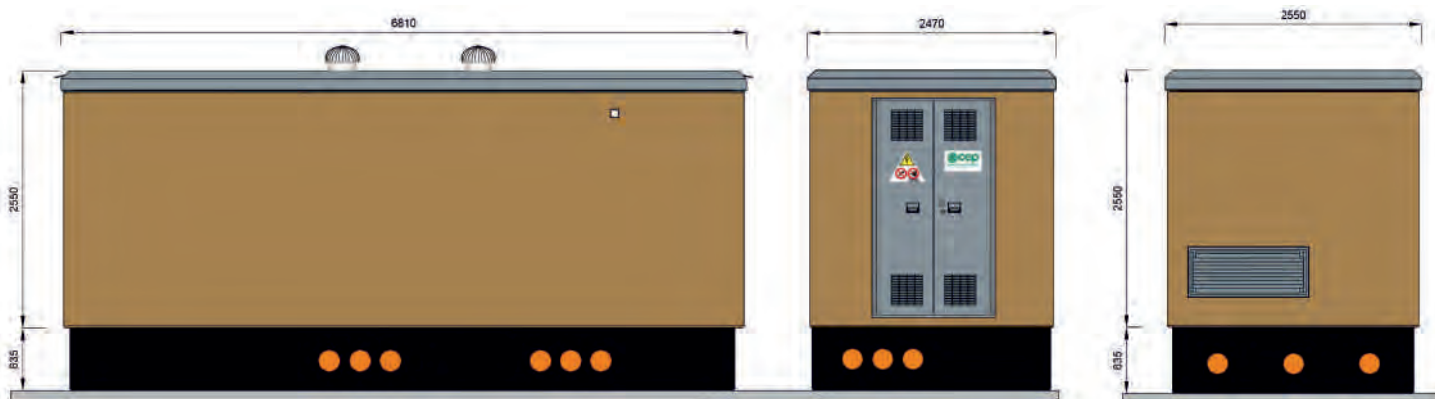

Vista Frontale
Frontal view

Vista Laterale
Side view

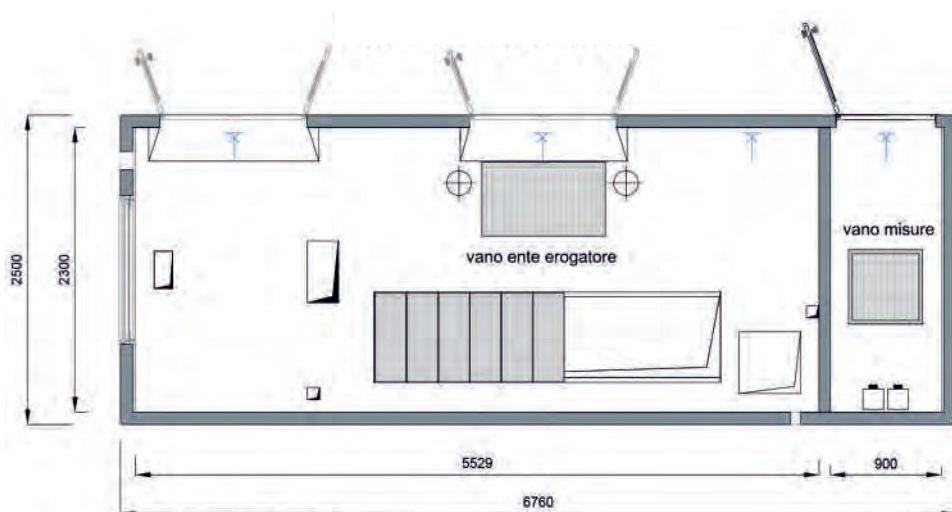

Vista su pianta
Plant view



P25 - 001 - Partenza Linea

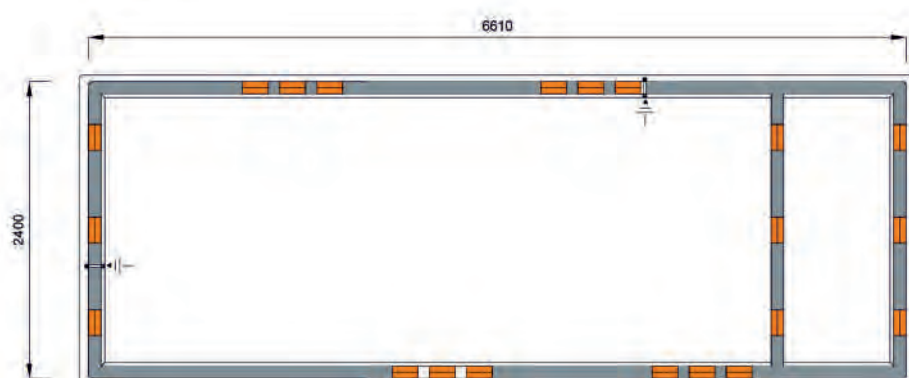

Vista su pianta vasca
Foundation plant view

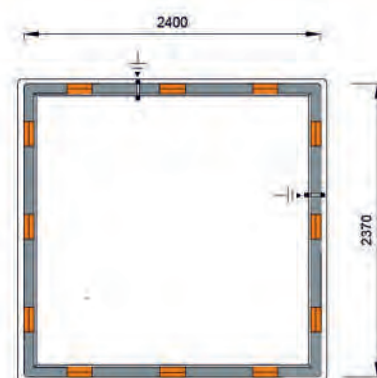

Quote e dimensioni scavo Digging quota and dimensions

Lunghezza - Length	m	12,00
Larghezza - Width	m	3,50
Profondità - Depth	m	0,60

**Box P67 e-distribuzione DG2061/7 Ed.09
"Standard Box Cliente"**

P25-002 fino a 400 kVA olio



Vista Frontale
Frontal view

Vista Laterale
Side view

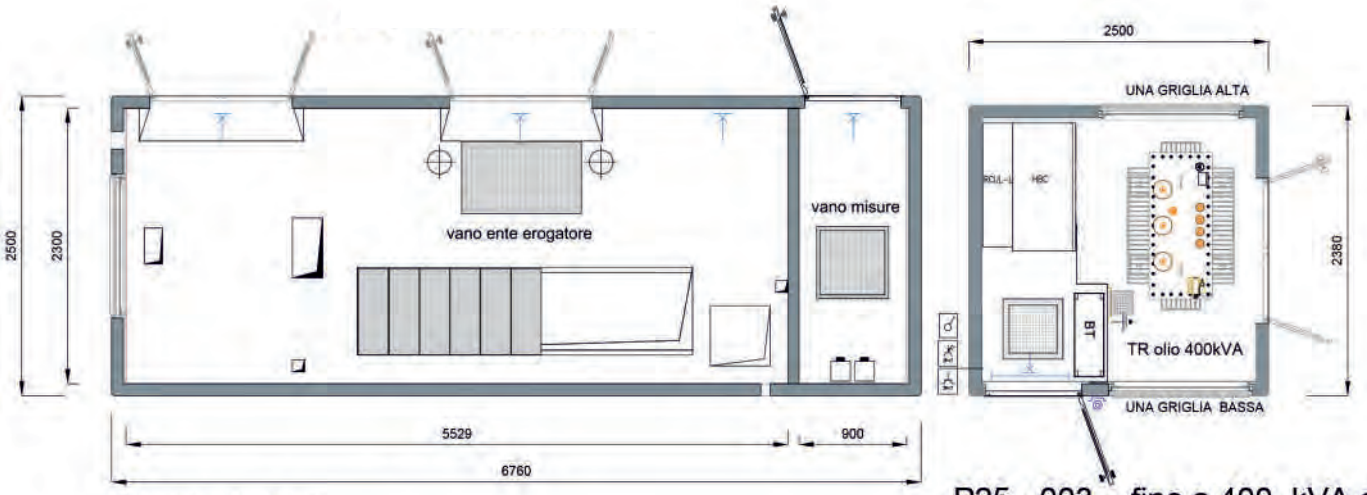

Vista su pianta
Plant view

P25 - 003 - fino a 400 kVA olio

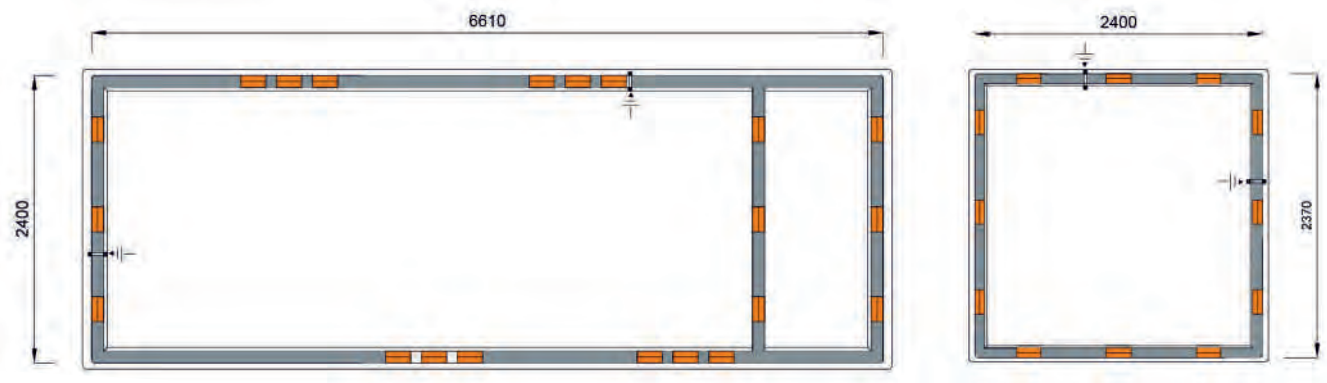

Vista su pianta vasca
Foundation plant view

Quote e dimensioni scavo Digging quota and dimensions		
Lunghezza - Length	m	12,00
Larghezza - Width	m	3,50
Profondità - Depth	m	0,60

Box P67 e-distribuzione DG2061/7 Ed.09 "Standard Box Cliente"

P25-002 fino a 400kVA resina



Vista Frontale
Frontal view

Vista Laterale
Side view

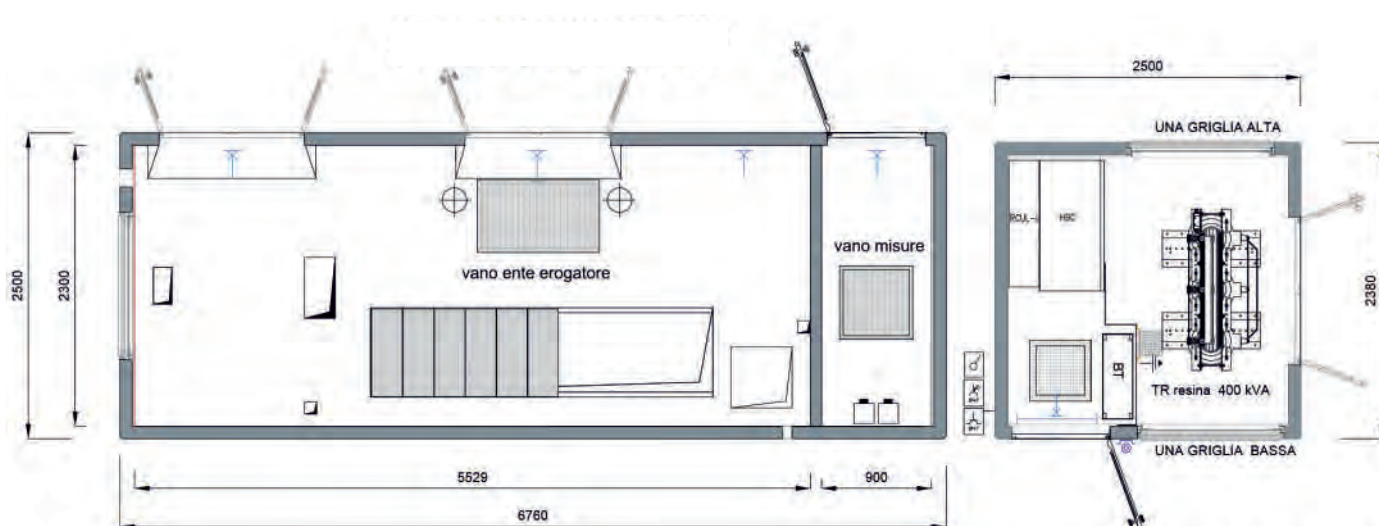

Vista su pianta
Plant view

P25 - 002 - fino a 400 kVA resina

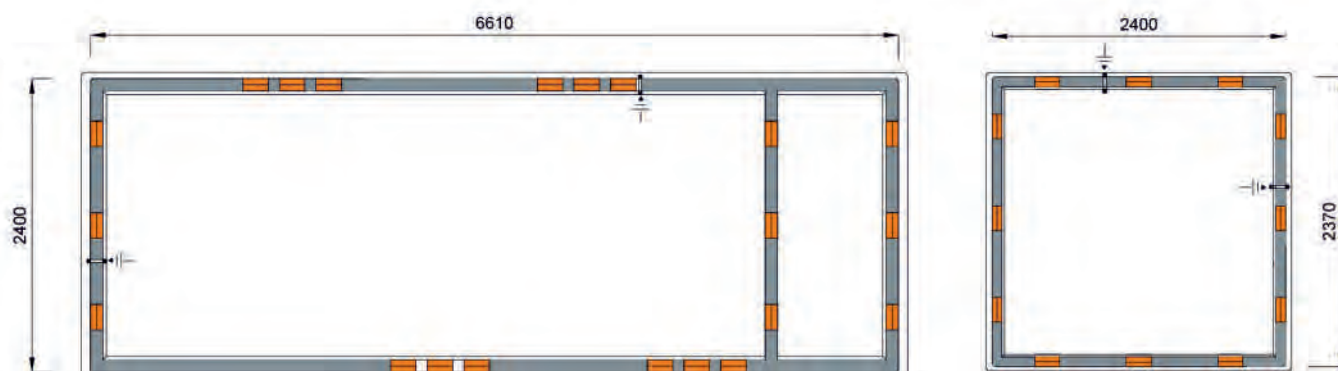

Vista su pianta vasca
Foundation plant view

Quote e dimensioni scavo Digging quota and dimensions

Lunghezza - Length	m	12,00
Larghezza - Width	m	3,50
Profondità - Depth	m	0,60

**Box P67 e-distribuzione DG2061/7 Ed.09
"Standard Box Cliente"**

P33-001 fino a 1000kVA olio



Vista Frontale
Frontal view

Vista Laterale
Side view

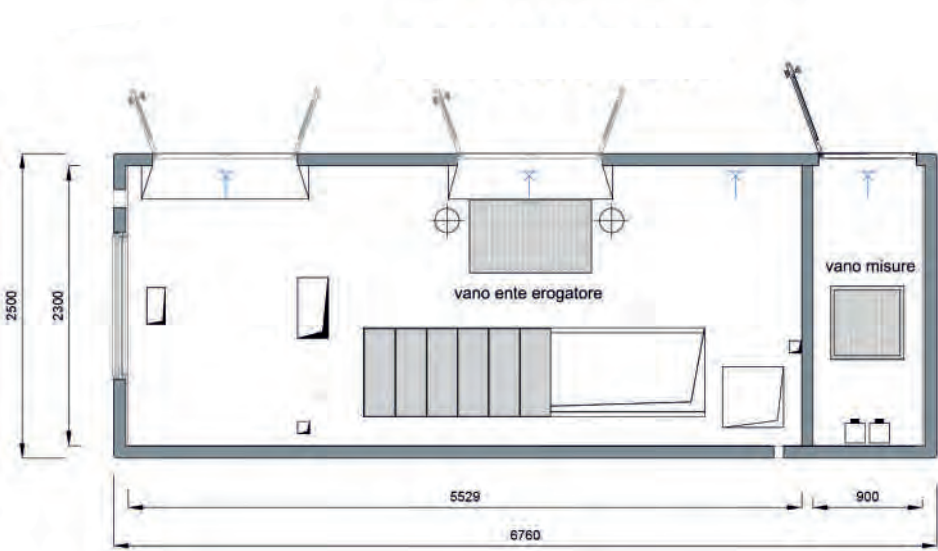

Vista su pianta
Plant view

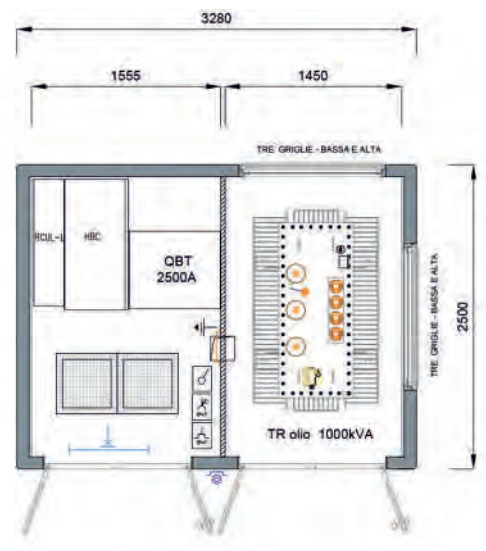

P33 - 001- fino a 1000 kVA olio

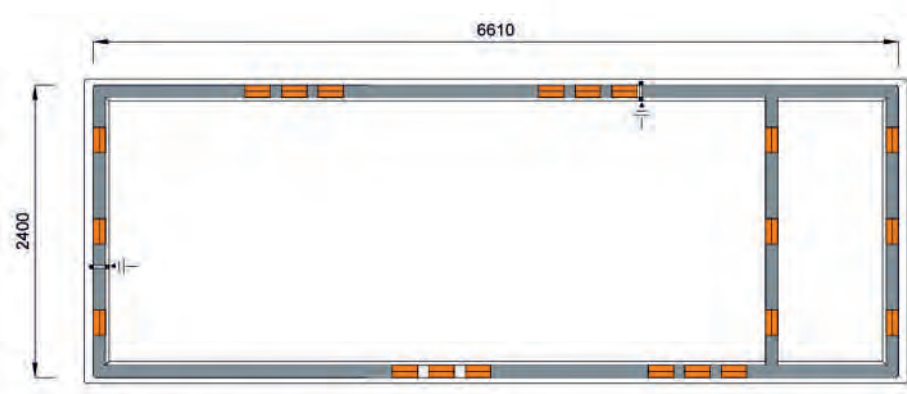

Vista su pianta vasca
Foundation plant view

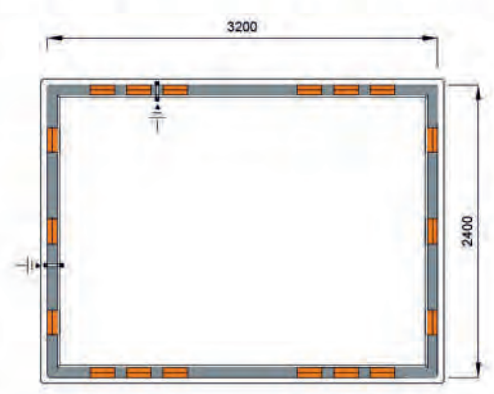

Quote e dimensioni scavo Digging quota and dimensions		
Lunghezza - Length	m	13,00
Larghezza - Width	m	3,50
Profondità - Depth	m	0,60

Box P67 e-distribuzione DG2061/7 Ed.09 "Standard Box Cliente"

P33-002 fino a 1600kVA resina



Vista Frontale
Frontal view

Vista Laterale
Side view

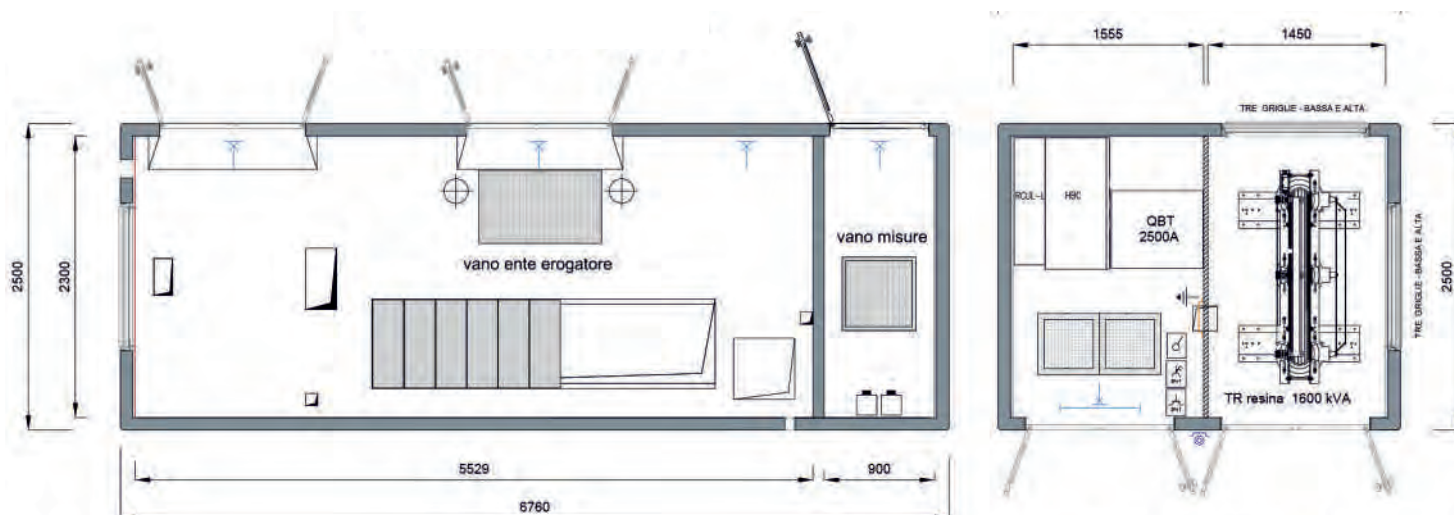

Vista su pianta
Plant view

P33 - 002- fino a 1600 kVA resina

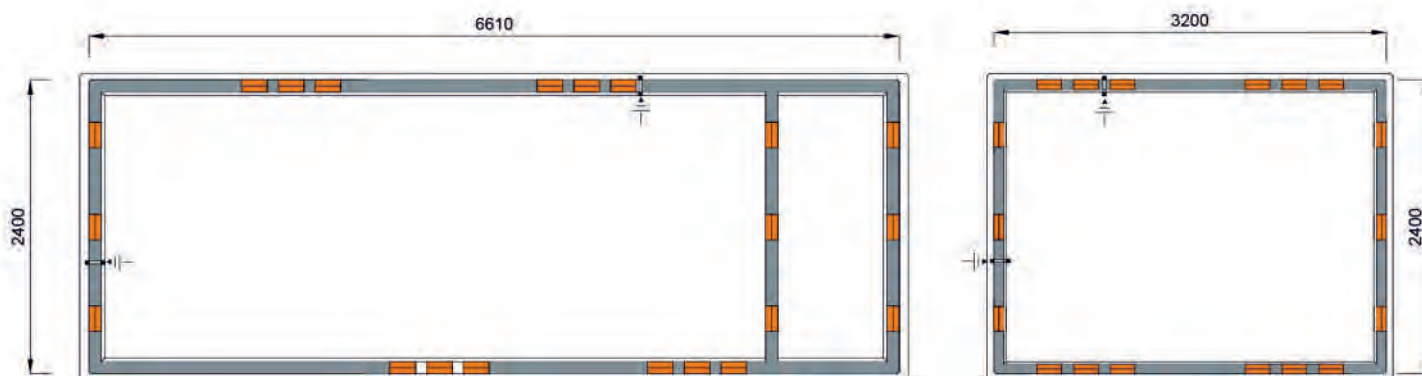

Vista su pianta vasca
Foundation plant view

Quote e dimensioni scavo Digging quota and dimensions

Lunghezza - Length	m	13,00
Larghezza - Width	m	3,50
Profondità - Depth	m	0,60

**Box P67 e-distribuzione DG2061/7 Ed.09
"Standard Box Cliente"**

P44-001 fino a 1600kVA olio

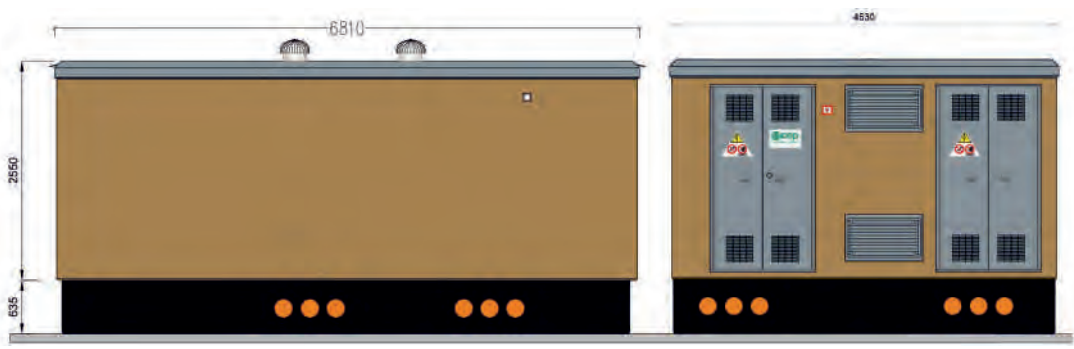

Vista Frontale
Frontal view

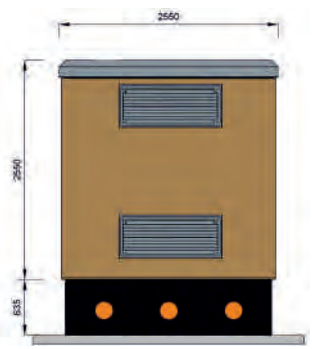

Vista Laterale
Side view

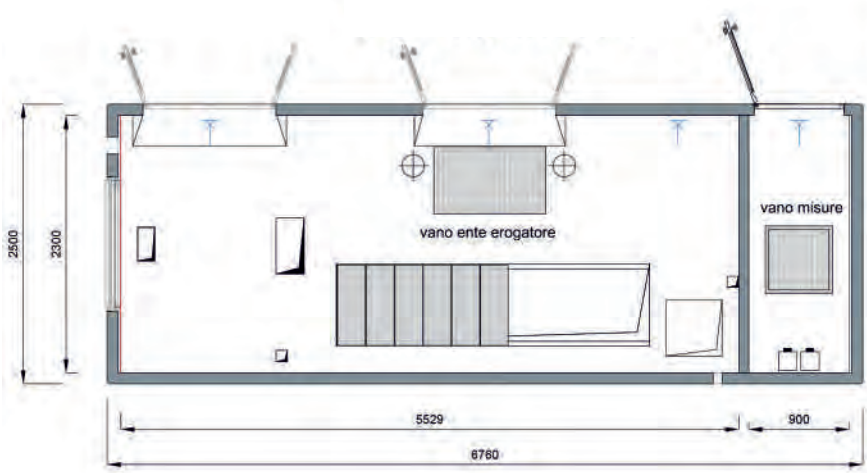

Vista su pianta
Plant view

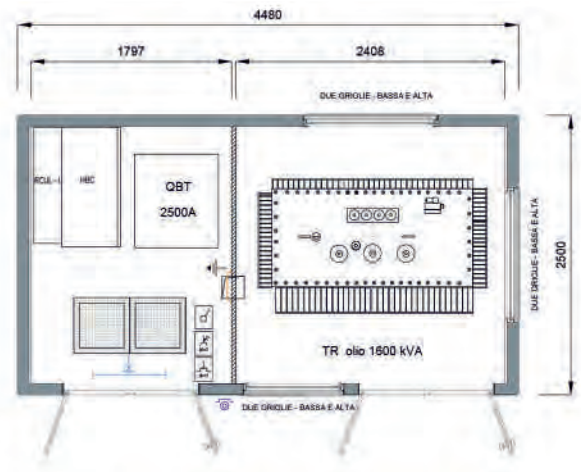

P44 - 001- fino a 1600 kVA olio

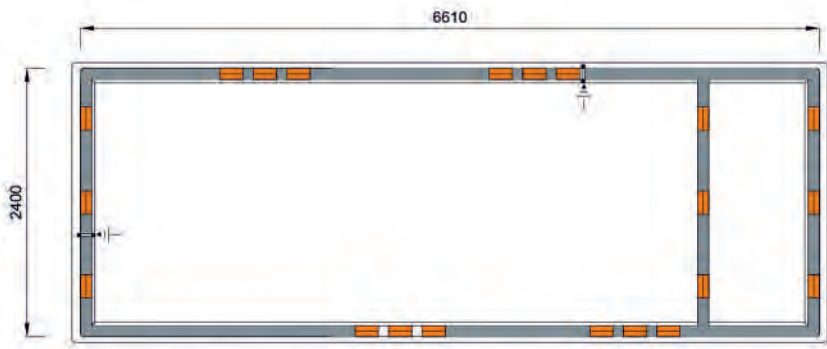

Vista su pianta vasca
Foundation plant view



Quote e dimensioni scavo Digging quota and dimensions		
Lunghezza - Length	m	13,50
Larghezza - Width	m	3,50
Profondità - Depth	m	0,60



Box P67 e-distribuzione DG2061/7 Ed.09 "Standard Box Cliente"

P44-002 fino a 1600kVA resina



Vista Frontale
Frontal view

Vista Laterale
Side view

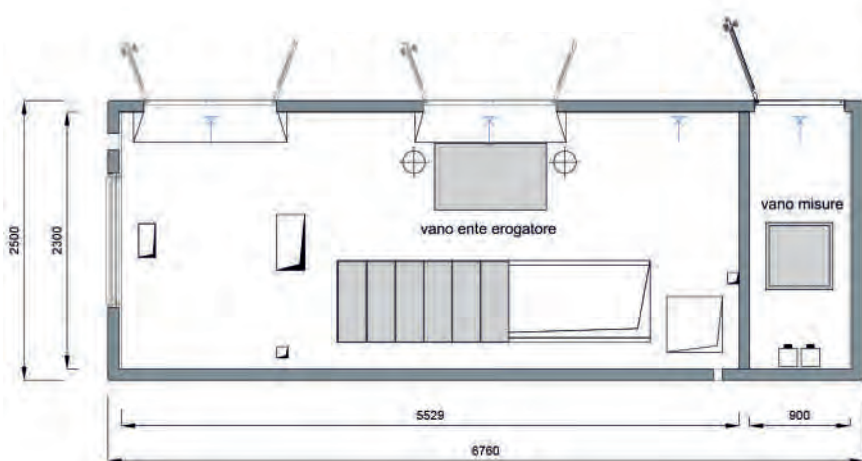

Vista su pianta
Plant view

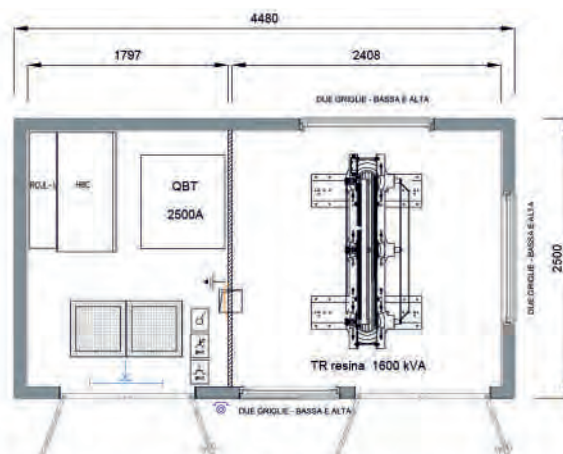

P44 - 002 - fino a 1600 kVA resina

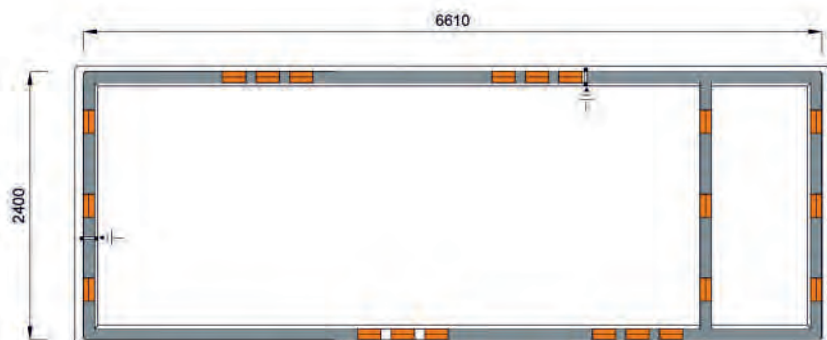

Vista su pianta vasca
Foundation plant view

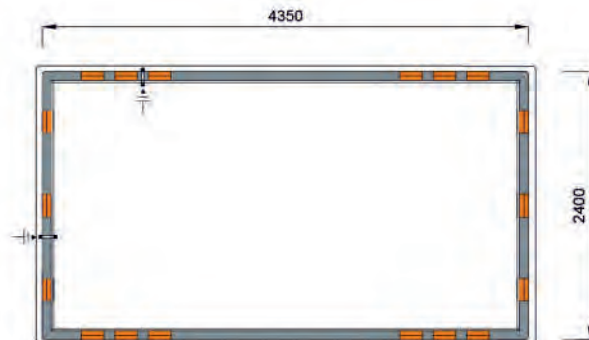

Quote e dimensioni scavo Digging quota and dimensions

Lunghezza - Length	m	13,50
Larghezza - Width	m	3,50
Profondità - Depth	m	0,60

**Box P67 e-distribuzione DG2061/7 Ed.09
"Standard Box Cliente"**

P57-001 fino a 2x400 kVA olio



Vista Frontale
Frontal view

Vista Laterale
Side view

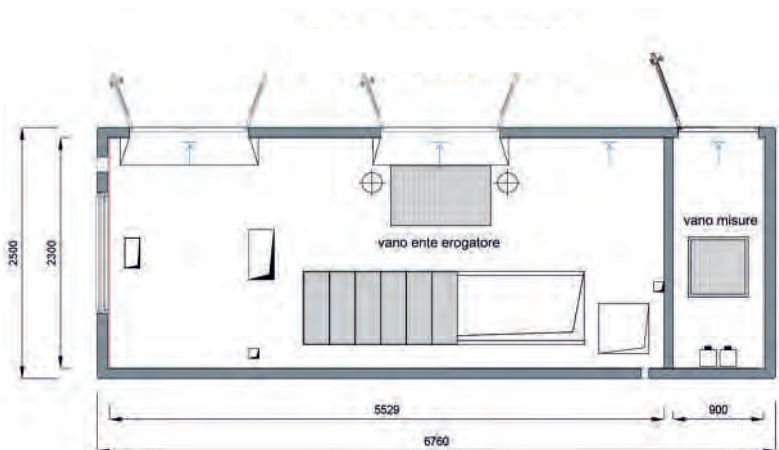

Vista su pianta
Plant view

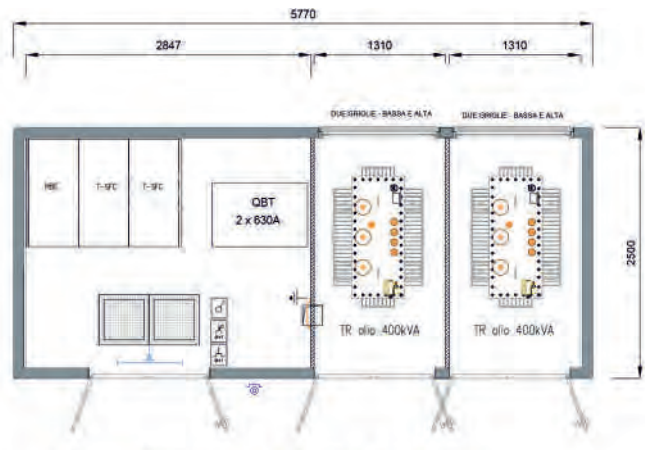

P57 - 001- fino a 2 x 400 kVA olio

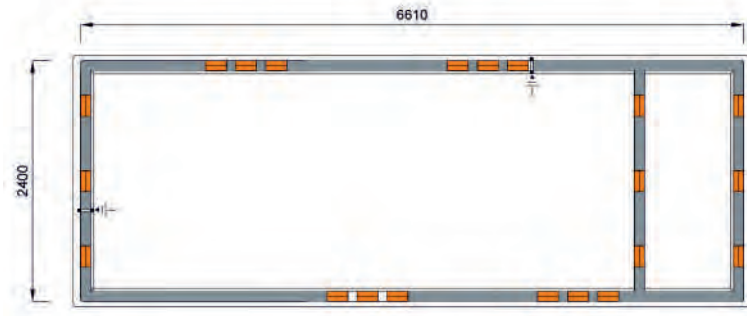

Vista su pianta vasca
Foundation plant view



Quote e dimensioni scavo Digging quota and dimensions		
Lunghezza - Length	m	16,00
Larghezza - Width	m	3,50
Profondità - Depth	m	0,60

Box P67 e-distribuzione DG2061/7 Ed.09 "Standard Box Cliente"

P57-002 fino a 2x400 kVA resina



Vista Frontale
Frontal view

Vista Laterale
Side view

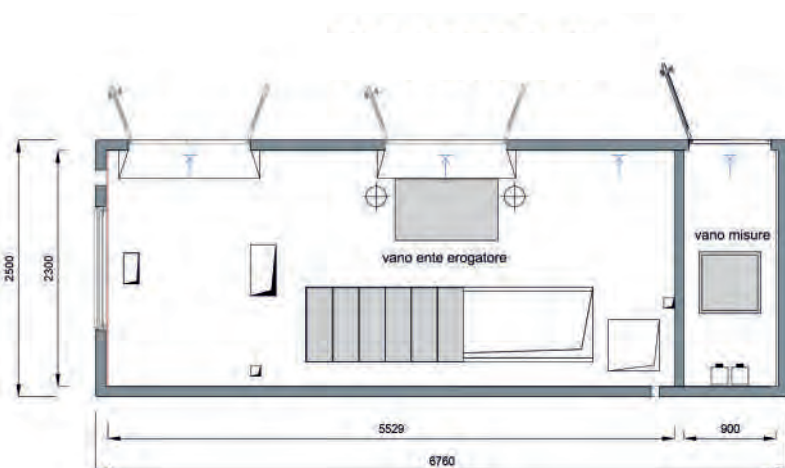

Vista su pianta
Plant view

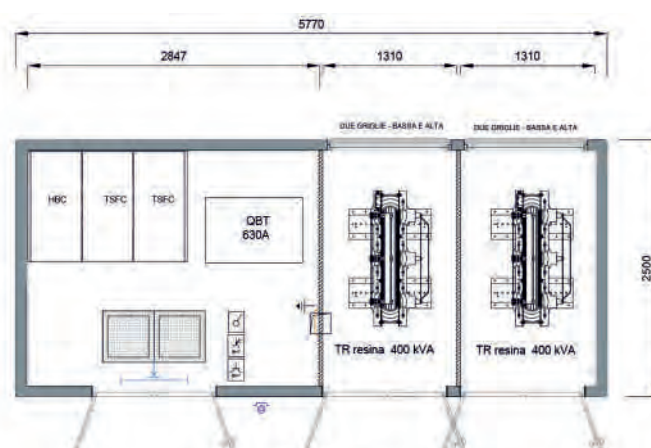

P57 - 002- fino a 2 x 400 kVA resina

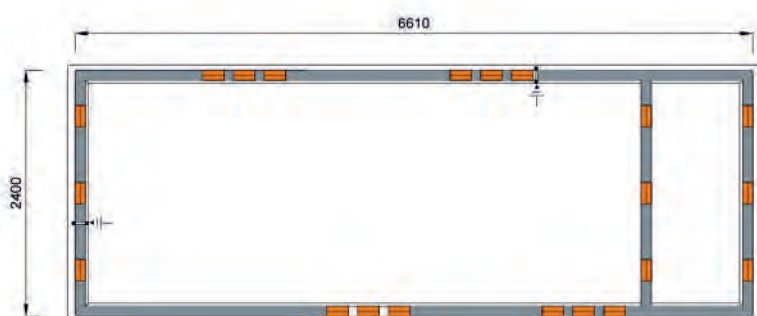

Vista su pianta vasca
Foundation plant view

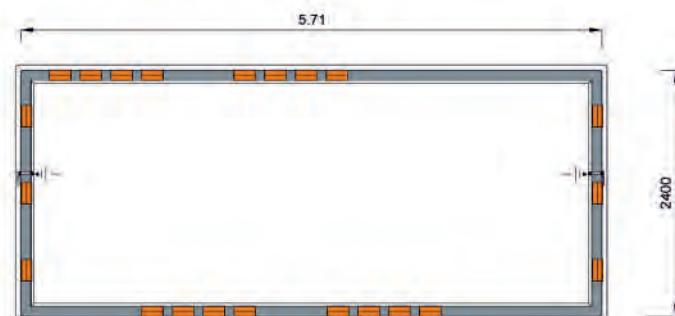

Quote e dimensioni scavo Digging quota and dimensions

Lunghezza - Length	m	16,00
Larghezza - Width	m	3,50
Profondità - Depth	m	0,60

**Box P67 e-distribuzione DG2061/7 Ed.09
"Standard Box Cliente"**

P67-001 fino a 2x1000 kVA olio



Vista Frontale
Frontal view

Vista Laterale
Side view

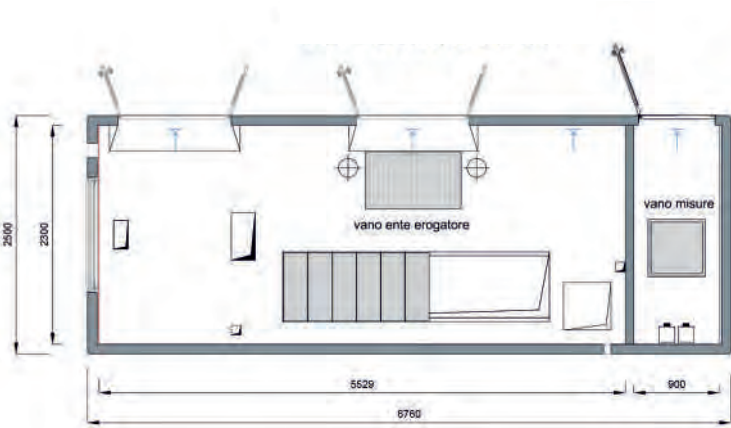

Vista su pianta
Plant view

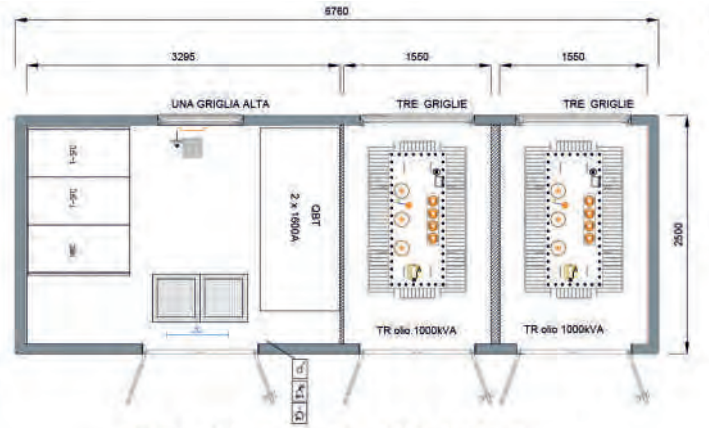

P67 - 001- fino a 2 x 1000 kVA olio

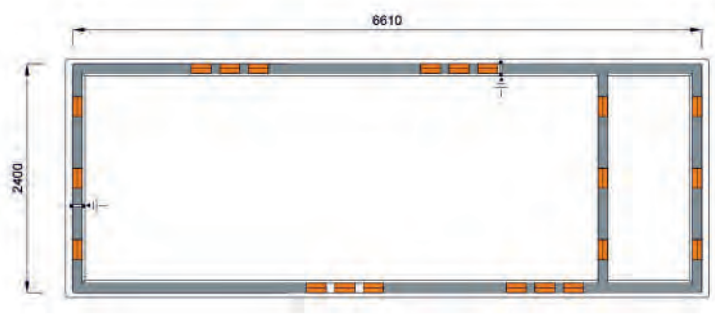

Vista su pianta vasca
Foundation plant view

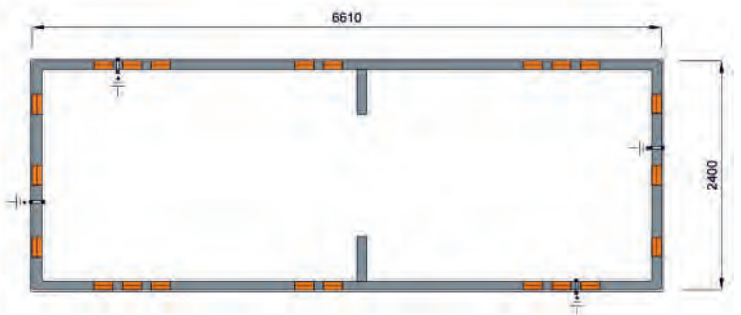

Quote e dimensioni scavo Digging quota and dimensions		
Lunghezza - Length	m	16,00
Larghezza - Width	m	3,50
Profondità - Depth	m	0,60

Box P67 e-distribuzione DG2061/7 Ed.09 "Standard Box Cliente"

P67-002 fino a 2x1000 kVA resina



Vista Frontale
Frontal view

Vista Laterale
Side view

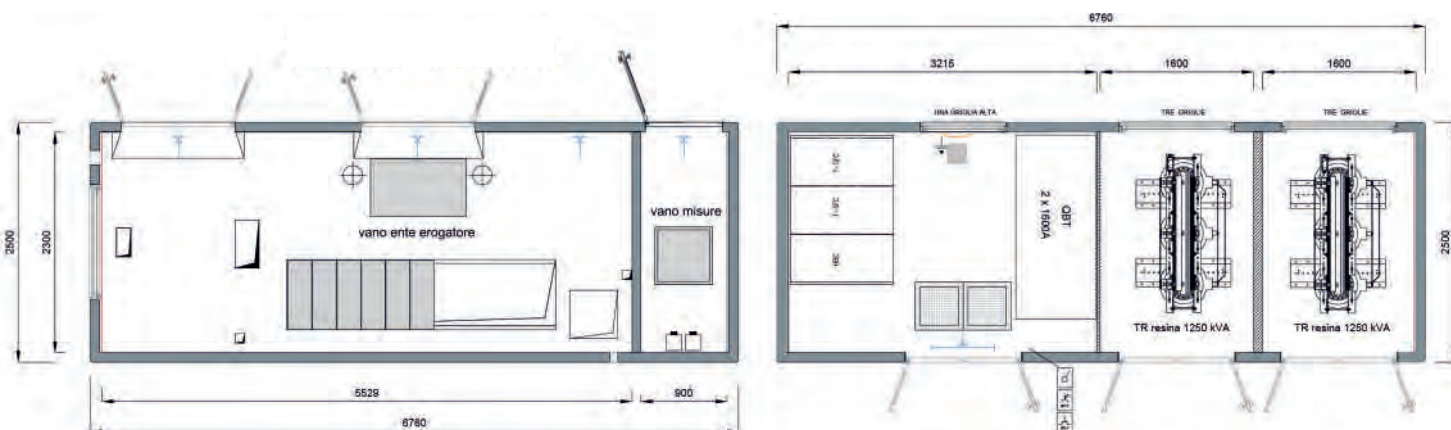

Vista su pianta
Plant view

P67 - 002- fino a 2 x 1000 kVA resina

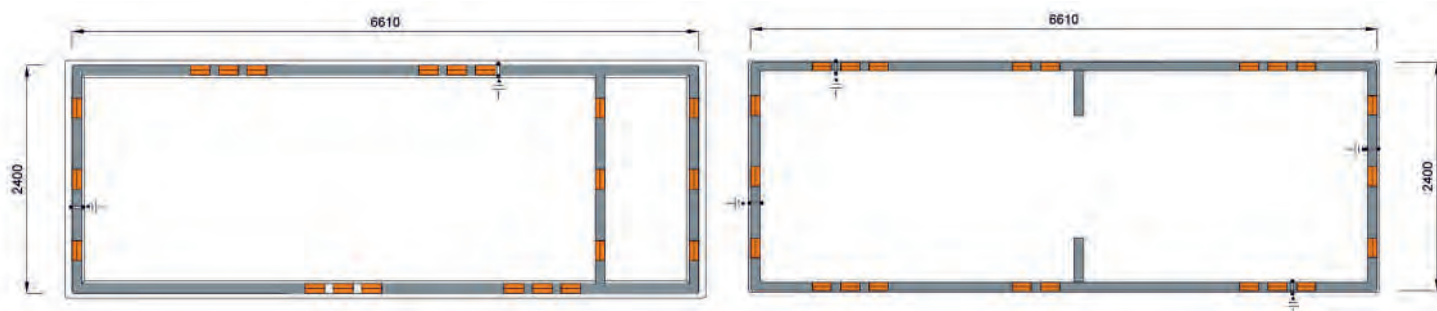

Vista su pianta vasca
Foundation plant view

Quote e dimensioni scavo Digging quota and dimensions

Lunghezza - Length	m	16,00
Larghezza - Width	m	3,50
Profondità - Depth	m	0,60

**Box P67 e-distribuzione DG2061/7 Ed.09
"Standard Box Cliente"**

P67-003 fino a 2x1250 kVA olio



Vista Frontale
Frontal view

Vista Laterale
Side view

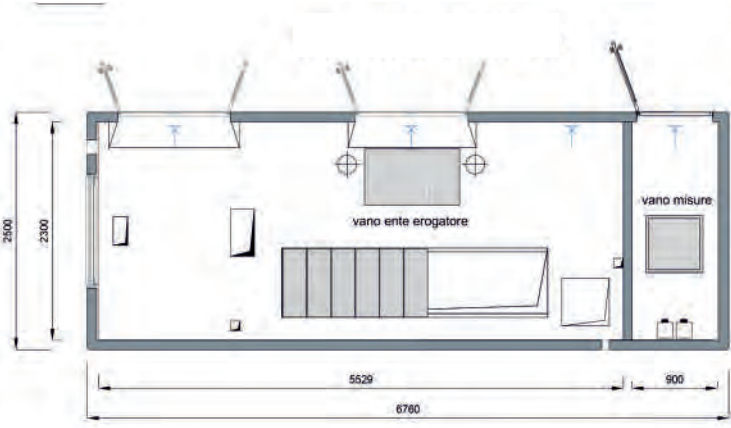

Vista su pianta
Plant view

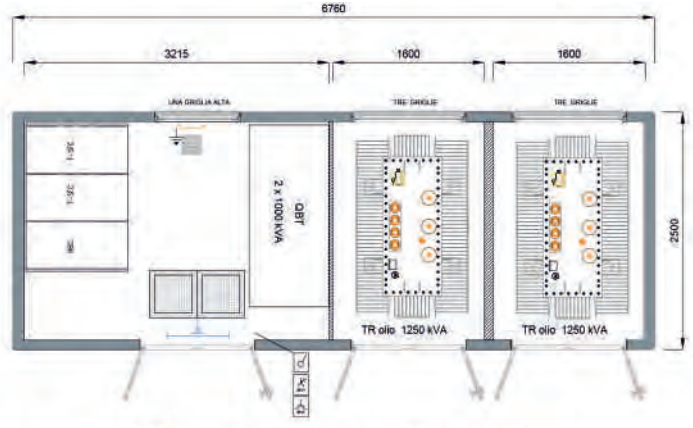

P67 - 003- fino a 2 x 1250 kVA olio

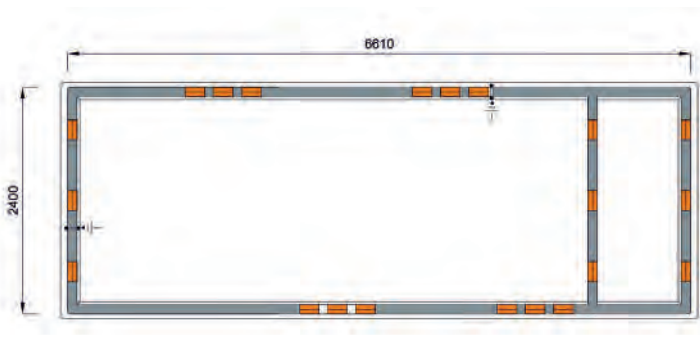

Vista su pianta vasca
Foundation plant view

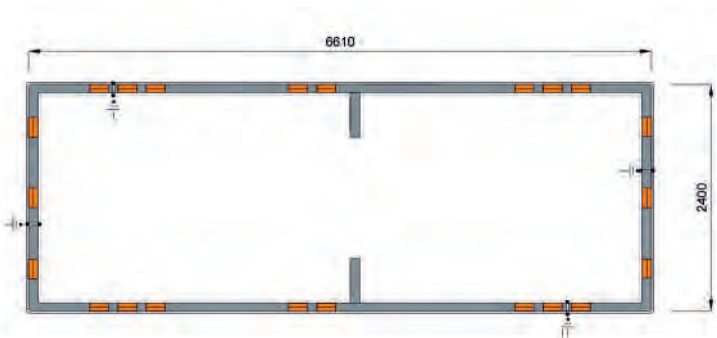

I disegni potrebbero non essere in scala. The drawings may not be to scale.

Quote e dimensioni scavo Digging quota and dimensions		
Lunghezza - Length	m	16,00
Larghezza - Width	m	3,50
Profondità - Depth	m	0,60

Box P67 e-distribuzione DG2061/7 Ed.09 "Standard Box Cliente"

P67-004 fino a 2x1250 kVA resina



Vista Frontale
Frontal view

Vista Laterale
Side view

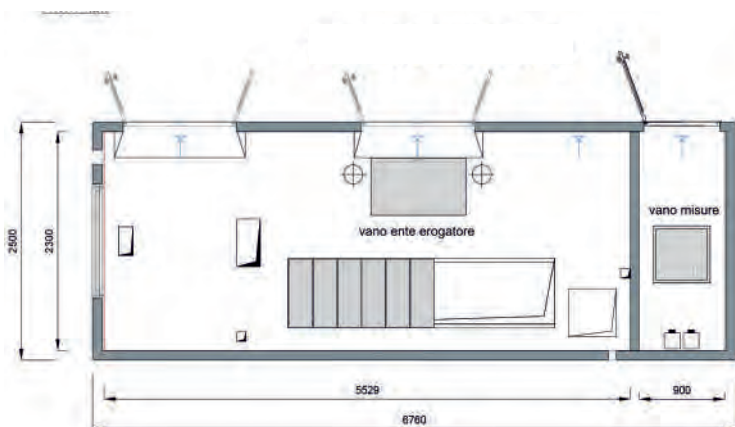

Vista su pianta
Plant view

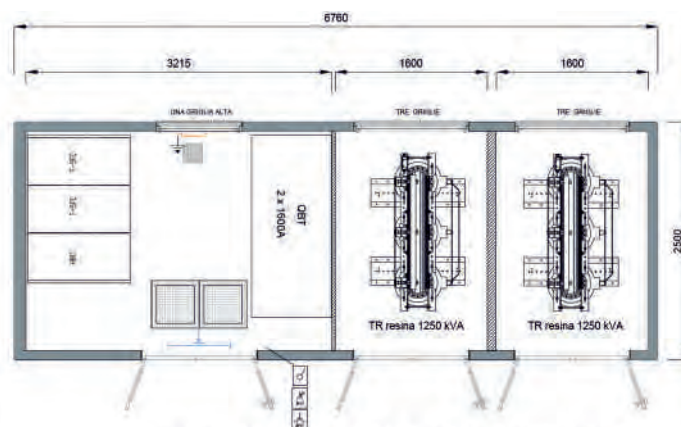

P67 - 004- fino a 2 x 1250 kVA resina

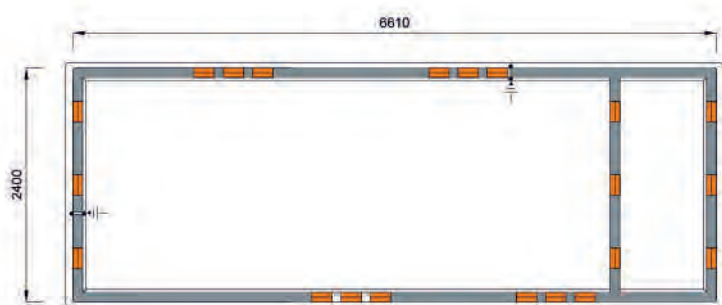

Vista su pianta vasca
Foundation plant view

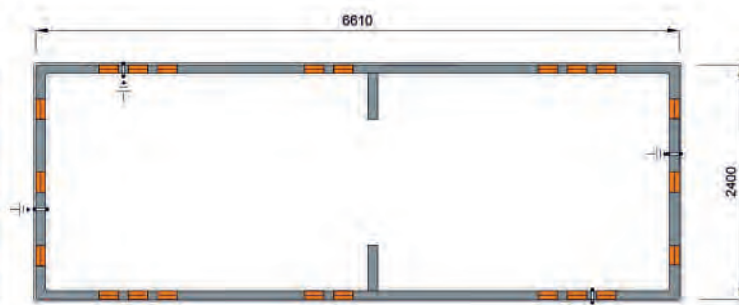

Quote e dimensioni scavo Digging quota and dimensions

Lunghezza - Length	m	16,00
Larghezza - Width	m	3,50
Profondità - Depth	m	0,60

P33-SI fino a 400kVA



Vista Frontale C
Frontal view C

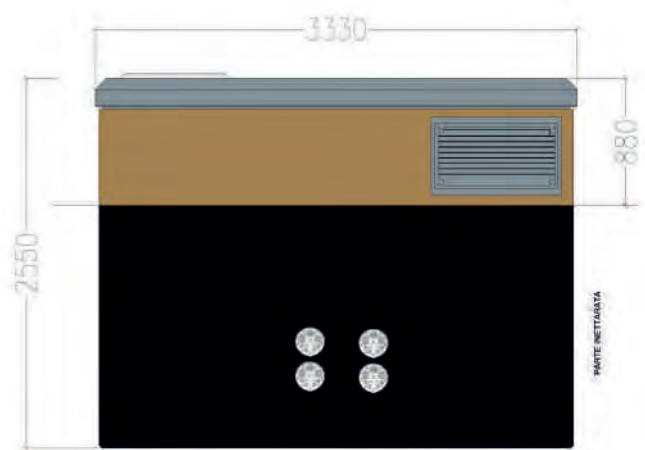

Vista Laterale D
Side view D

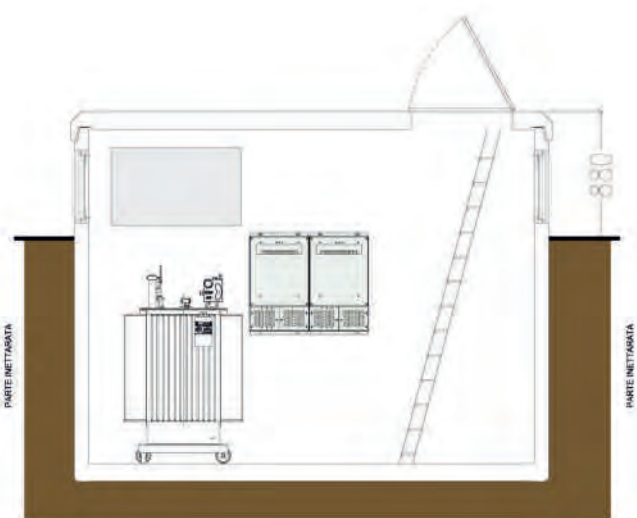

Vista su pianta A
Plant view A

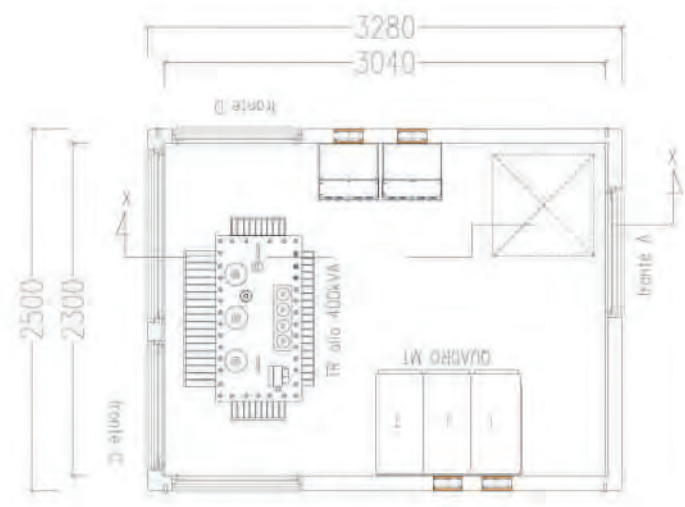

Vista su pianta B
Plant view B

Quote e dimensioni scavo Digging quota and dimensions		
Lunghezza - Length	m	4,50
Larghezza - Width	m	3,50
Profondità - Depth	m	1,67



 **cep**
Componenti Elettrici e Prefabbricati

 **cep**
Componenti Elettrici e Prefabbricati

Sezioni tipo

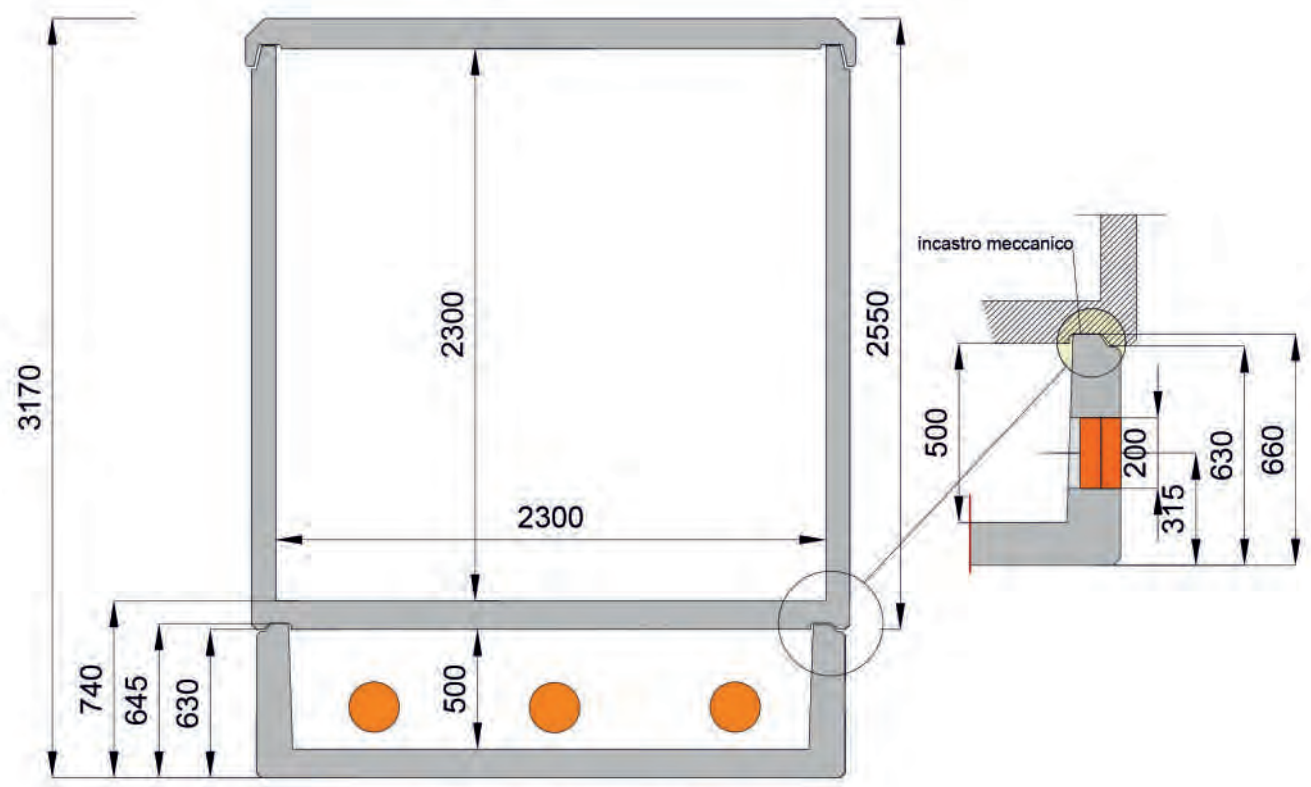

Sezione Tipo cabine tipo P25-P33-P44-P57-P67

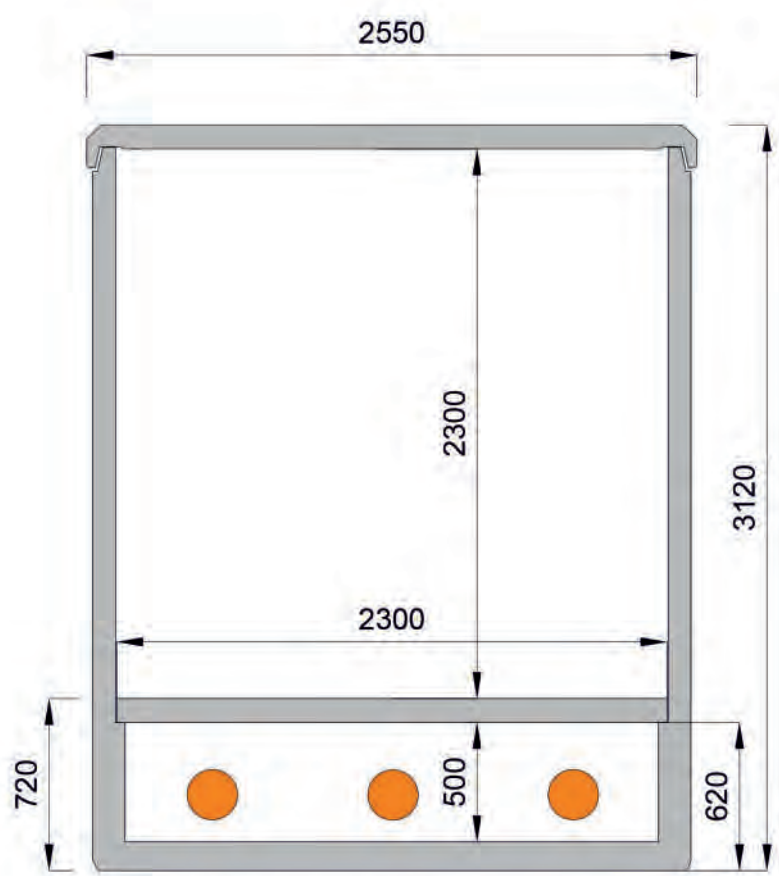

Sezione Tipo cabina - P87

cep



Componenti Elettrici e Prefabbricati

Condizioni ottimali in cui operare in sicurezza lo scarico dei manufatti

Transport and downloading conditions for concrete electrical stations

Le opere edili distinti in scavo, costruzione della maglia di terra e livellamento fondo dello scavo nonché eventuali costruzioni di strade temporanee al fine di raggiungere la piazzola di scarico saranno esclusivamente a carico del cliente.

Il trasporto e lo scarico saranno coordinate dalla CEP srl che con congruo anticipo contatterà il responsabile di cantiere al fine di concordare la data effettiva in cui effettuare lo scarico.

L'area prossima allo scavo deve consentire l'accesso di un rimorchio lungo 16m, largo 2,50m, alto 5m e del peso di 50t; deve essere carrabile, duramente costipato e a livello in piano orizzontale.

La massima distanza misurata dal centro della gru al centro della cabina è di 6m; il rimorchio e la gru devono essere piazzati in parallelo come rappresentato nelle figure seguenti.

Qualora il piazzamento dei mezzi affiancati non sia possibile sarà necessaria una gru di portata superiore o di mezzi speciali che vanno concordati preventivamente.

Tutti gli ostacoli, recinti, muri, linee elettriche ed eventuali distacchi di tensione, alberi, pali, fossi, e quant'altro possa ostacolare la manovra in sicurezza della gru, devono essere eliminati dal cliente prima dell'inizio delle operazioni di scarico.

Tutte le suddette operazioni saranno effettuate nel rispetto delle normative e leggi vigenti.

Construction works as excavation, construction of ground grid and levelling operations at the bottom of the excavated area, as well as possible buildings of temporary roads in order to reach the download area, will be exclusively charged to the customer.

Transport and downloading will be coordinated by CEP srl that will contact the site Manager in due time in order to agree the effective date of downloading.

The area close to the excavation must give access to a trailer long 16m, large 2,50m, high 5m and weighing 50t; it must be suitable for driveways, properly compacted and at horizontal level.

The maximum measured distance from the centre of the crane to the centre of the station is 6m; trailer and crane must be placed in parallel lines as shown in the following images.

If the placement of the vehicles in line is not possible, it will be necessary a higher capacity load crane or special vehicles previously agreed.

All the obstacles, fences, walls, power lines and possible power disconnections, trees, poles, holes and everything can obstruct the manoeuvre of the crane in safety conditions must be removed by the customer before the beginning of downloading operations.

All the above mentioned operations will be carried out with full and rigorous compliance with the laws and regulations in force.



SOLUZIONE A

Caso in cui l'area di piazzamento della gru prevede l'affiancamento del semirimorchio

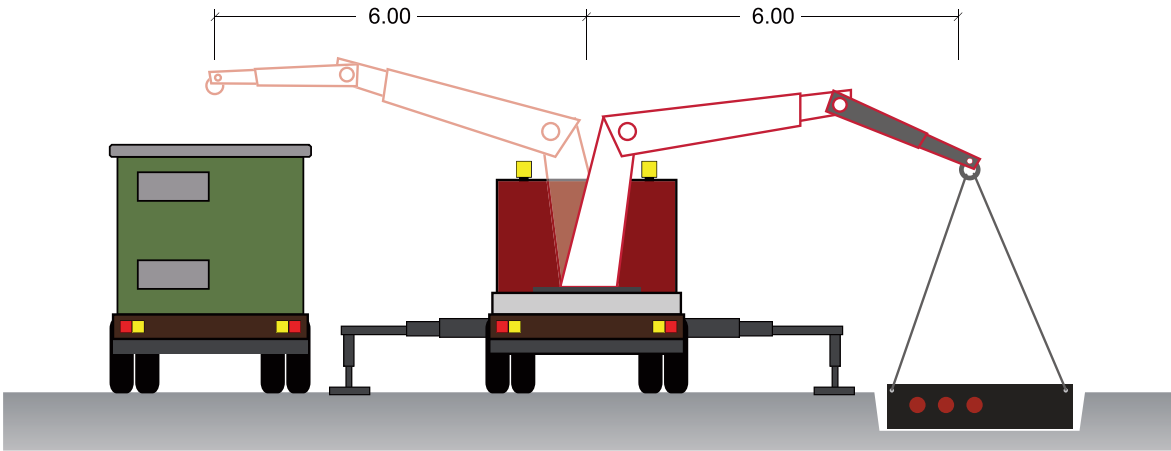

12.00 vista frontale

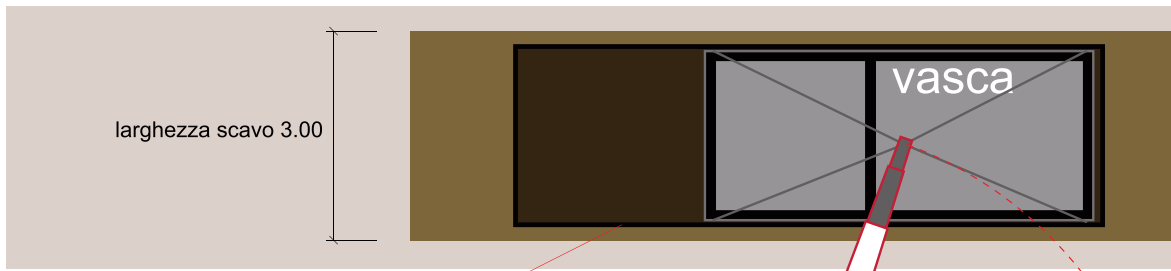

limite dello scavo

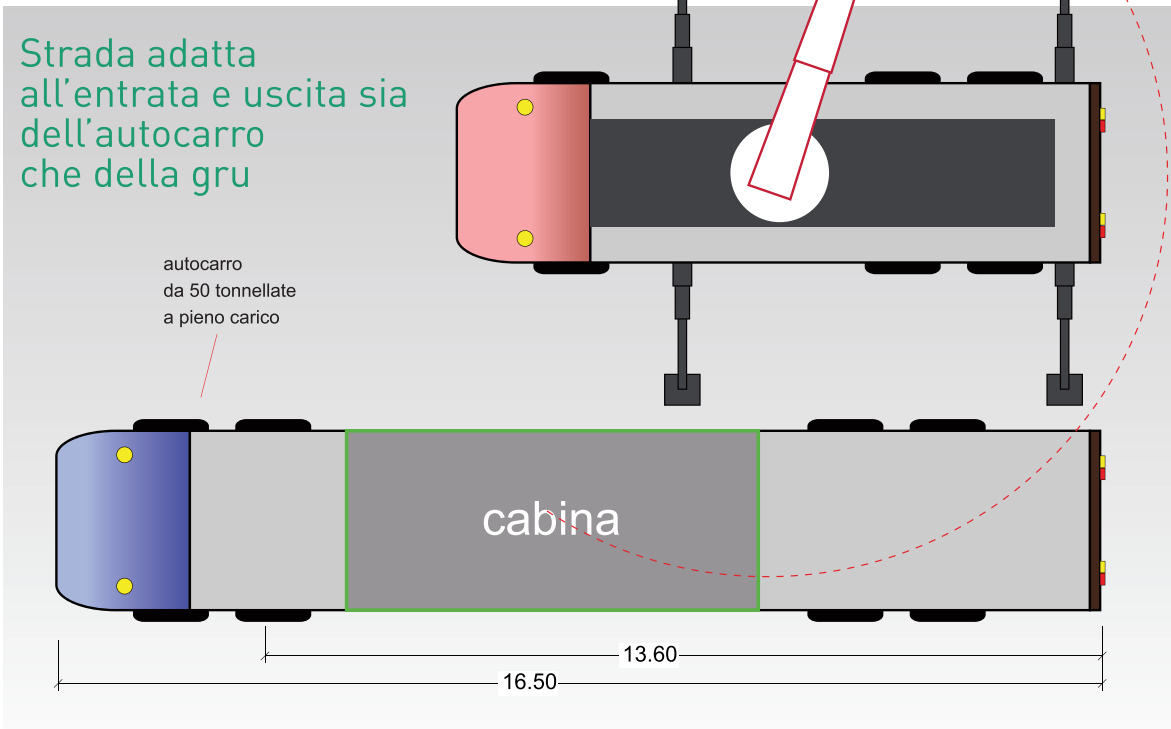

Strada adatta all'entrata e uscita sia dell'autocarro che della gru

autocarro da 50 tonnellate a pieno carico

cabina

SOLUZIONE B
 Caso in cui l'area di piazzamento della gru
 non prevede la possibilità di affiancamento
 del semirimorchio

Strada interpoderale
 o interna al campo
 pianeggiante

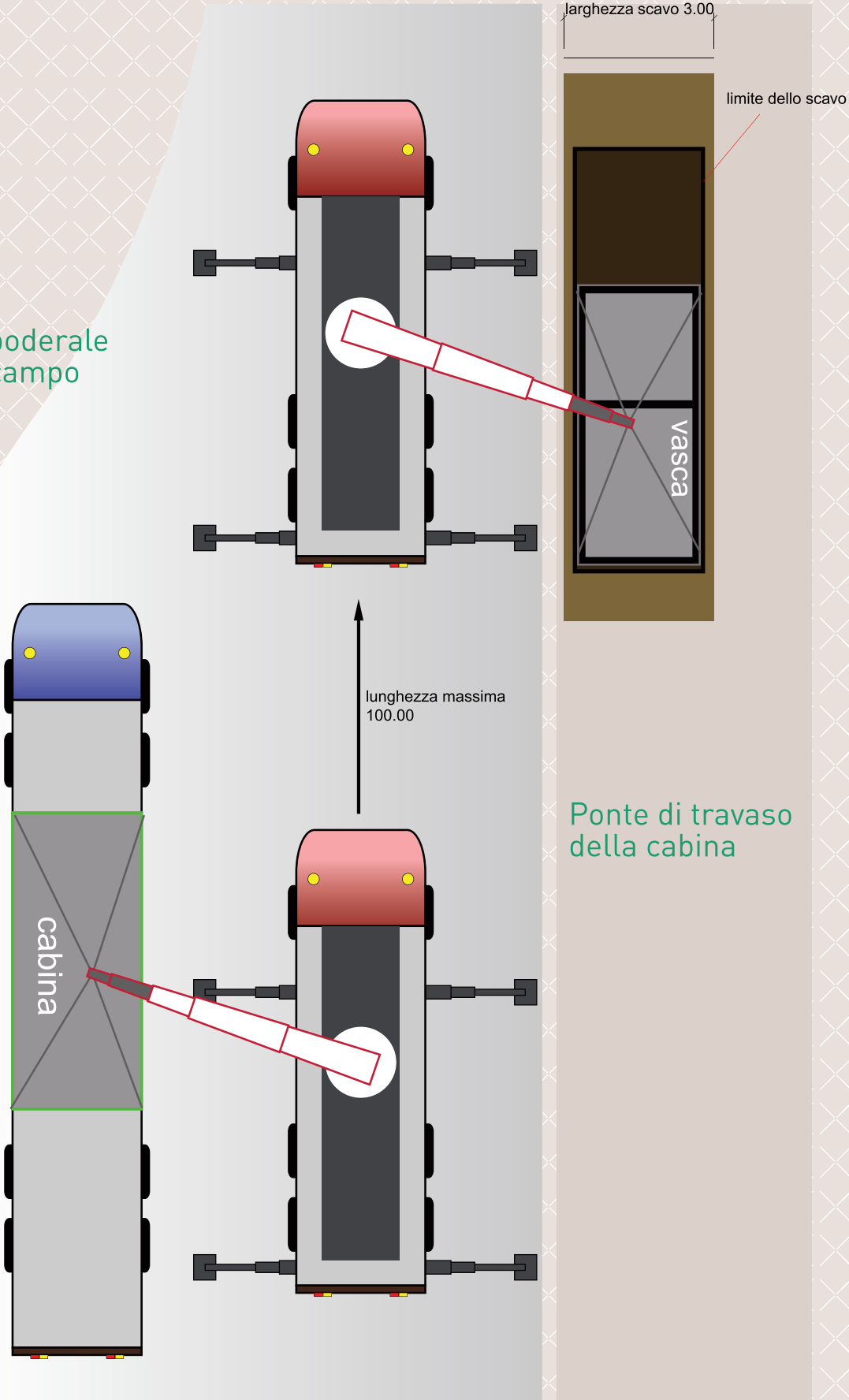

ESEMPI DI PIAZZAMENTO DELL' AUTOGRU





Sede Legale, Stabilimenti e Uffici:
ZONA INDUSTRIALE FEGOTTO
91013 CALATAFIMI SEGESTA (TP)
tel. 0924 514486 - fax 0924 040017
www.cepsrl.it - cepsrl@cepsrl.it

www.cepsrl.it

Tenendo conto dell'evoluzione sia delle Norme sia dei materiali, le caratteristiche e le dimensioni di ingombro riportate nel presente catalogo si potranno ritenere impegnative solo dopo la conferma da parte di Cep srl.
Due to the continuous development of Standards as well as materials, the characteristics and dimensions indicated in this catalogue must be regarded as binding only after confirmation from Cep srl.